

Infusion 180

BLH7050

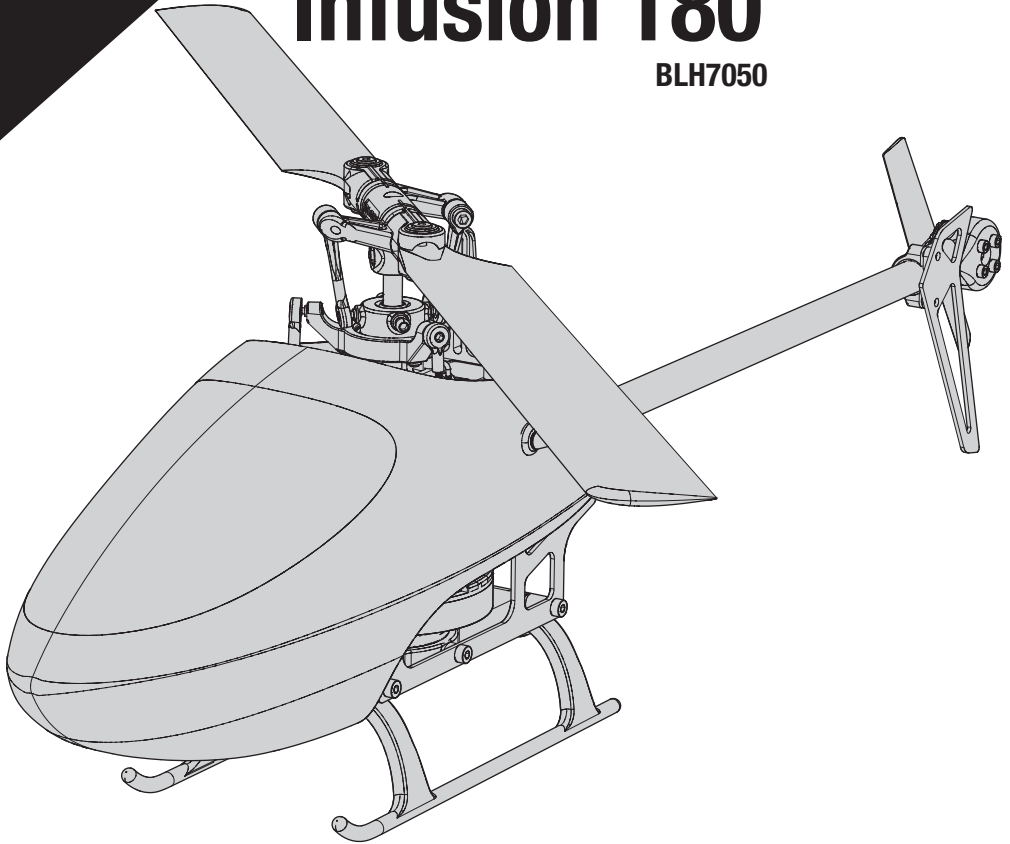

Instruction Manual
Bedienungsanleitung
Manuel d'utilisation
Manuale di Istruzioni

NOTICE

All instructions, warranties and other collateral documents are subject to change at the sole discretion of Horizon Hobby, LLC. For up-to-date product literature, visit horizonhobby.com or towerhobbies.com and click on the support or resources tab for this product.

Meaning of Special Language

The following terms are used throughout the product literature to indicate various levels of potential harm when operating this product:

WARNING: Procedures, which if not properly followed, create the probability of property damage, collateral damage, and serious injury OR create a high probability of superficial injury.

CAUTION: Procedures, which if not properly followed, create the probability of physical property damage AND a possibility of serious injury.

NOTICE: Procedures, which if not properly followed, create a possibility of physical property damage AND a little or no possibility of injury.

 **WARNING:** Read the ENTIRE instruction manual to become familiar with the features of the product before operating. Failure to operate the product correctly can result in damage to the product, personal property and cause serious injury.

This is a sophisticated hobby product. It must be operated with caution and common sense and requires some basic mechanical ability. Failure to operate this Product in a safe and responsible manner could result in injury or damage to the product or other property. This product is not intended for use by children without direct adult supervision. Do not use with incompatible components or alter this product in any way outside of the instructions provided by Horizon Hobby, LLC. This manual contains instructions for safety, operation and maintenance. It is essential to read and follow all the instructions and warnings in the manual, prior to assembly, setup or use, in order to operate correctly and avoid damage or serious injury.

Age Recommendation: Not for children under 14 years. This is not a toy.

Safety Precautions and Warnings

- Always keep a safe distance in all directions around your model to avoid collisions or injury. This model is controlled by a radio signal subject to interference from many sources outside your control. Interference can cause momentary loss of control.
- Always operate your model in open spaces away from full-size vehicles, traffic and people.
- Always carefully follow the directions and warnings for this and any optional support equipment (chargers, rechargeable battery packs, etc.).
- Always keep all chemicals, small parts and anything electrical out of the reach of children.
- Always avoid water exposure to all equipment not specifically designed and protected for this purpose. Moisture causes damage to electronics.
- Never place any portion of the model in your mouth as it could cause serious injury or even death.
- Never operate your model with low transmitter batteries.
- Always keep aircraft in sight and under control.
- Always move the throttle fully down at rotor strike.
- Always use fully charged batteries.
- Always keep transmitter powered on while aircraft is powered.
- Always remove batteries before disassembly.
- Always keep moving parts clean.
- Always keep parts dry.
- Always let parts cool after use before touching.
- Always remove batteries after use.
- Never operate aircraft with damaged wiring.
- Never touch moving parts.

 **WARNING AGAINST COUNTERFEIT PRODUCTS:** If you ever need to replace your Spektrum receiver found in a Horizon Hobby product, always purchase from Horizon Hobby, LLC or a Horizon Hobby authorized dealer to ensure authentic high-quality Spektrum product. Horizon Hobby, LLC disclaims all support and warranty with regards, but not limited to, compatibility and performance of counterfeit products or products claiming compatibility with DSM or Spektrum technology.

Table of Contents

First Flight Preparation.....	4	Trim Flight	13
Flying Checklist	4	Calibration Procedure (Non-Forward Programming)	13
Transmitter Setup Table (BNF)	4	Post-Flight Inspection and Maintenance Checklist.....	14
Installing the Flight Battery	5	Troubleshooting Guide	14
Transmitter and Receiver Binding.....	6	Exploded View	16
SAFE Technology	7	Parts Listings	17
Flight Mode and Rate Selection.....	7	Optional Parts	17
Panic Recovery	7	Limited Warranty	17
Throttle Hold	8	Warranty and Service Contact Information	18
Control Tests	8	FCC Information.....	18
Understanding the Primary Flight Controls	9	IC Information.....	19
Flying the Infusion 180	10	Compliance Information for the European Union.....	19

Specifications

Length	15.5 in (394mm)	Tail Rotor Diameter	2.95 in (75mm)
Height	4.64 in (118 mm)	Flying Weight	11.95oz (280 g)
Main Rotor Diameter	15.75in (400mm)		

Components

		BLH7050
Airframe	Blade Infusion 180	Included
Main Motor	650Kv Brushless (SPMXHM1005)	Installed
Tail Motor	5500Kv Brushless (SPMXHM1010)	Installed
Receiver/Flight Control	Blade Infusion 180 AS3X®/ Smart® receiver (SPMAR6251MHX)	Installed
ESC	Brushless ESC (SPMXAE1020A)	Installed
Servos	12g MG Heli Cyclic Servo (SPMSH2080)	Installed
Battery	600mAh 3S 11.1V 30C Li-Po iC2 (SPMX6003S50)	Not Included
Charger	3 Cell Smart Charger (\$155 SPMXC2050 Spektrum Smart charger recommended)	Not Included
Transmitter	DSM2®/DSMX® Compatible Transmitter	Not Included
Adapter	iC2 to iC3 charge adapter (SPMXCA320)	Not Included

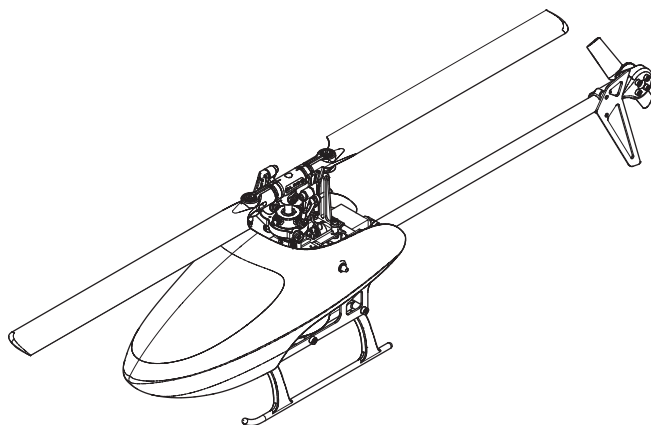

First Flight Preparation

- Remove and inspect contents
- Begin charging the flight battery
- Program your computer transmitter (BNF only)
- Charge the flight battery
- Install the flight battery
- Bind your transmitter (BNF only)
- Familiarize yourself with the controls
- Find a suitable area for flying

Flying Checklist

- Always turn the transmitter on first**
- Plug the flight battery into the lead from the ESC
- Allow the receiver and ESC to initialize and arm properly
- Fly the model
- Land the model
- Unplug the flight battery from the ESC
- Always turn the transmitter off last**

Transmitter Setup Table (BNF)

DX6e, DX6, DX7, DX8, DX9, DX18, DXs0, iX12, iX20, NX6, NX8, NX10

SYSTEM SETUP		FUNCTION LIST											
Model Type	HELI	Servo Setup											
Swash Type	Normal	Chan	Travel	Reverse	Chan	Travel	Reverse						
F-Mode Setup		THR	100/100	Normal	PIT	100/100	Normal						
Switch 1	Switch B	AIL	100/100	Normal	AX2	100/100	Normal						
Switch 2	Inhibit	ELE	100/100	Normal	AX3	100/100	Normal						
Hold Switch	Switch H	RUD	100/100	Normal	AX4	100/100	Normal						
	0 1	GER	100/100	Normal	Throttle Curve								
Channel Assign		D/R & Expo				Sw (B) Pos	Pt 1	Pt 2	Pt 3	Pt 4	Pt 5		
Channel Input Config		Chan	Sw (F) Pos	D/R	Expo	N	0	65	65	65	65		
1 Throttle		AILE	0	100/100	+25	1	80	80	80	80	80		
2 Aileron			1	100/100	+25	2	100	100	100	100	100		
3 Elevator			2	75/75	+25	Pitch Curve							
4 Rudder		ELEV	0	100/100	+25	Sw (B) Pos	Pt 1	Pt 2	Pt 3	Pt 4	Pt 5		
5 Gear	F-Mode		1	100/100	+25	N	30	40	50	75	100		
6 Collective		RUDD	0	100/100	+25	1	0	25	50	75	100		
7 AUX 2			1	100/100	+25	2	0	25	50	75	100		
			2	75/75	+25	HOLD	25	37	50	75	100		
Frame Rate		Gyro						Mixing					
11ms		Inhibit						P-Mix 1	Normal				
DSMX		Timer							Channels	-I- > Ger			
		Mode	Count Down			Time	Rate		0/-125				
		Start	5:00v			Start	Offset		100				
		Over	25%			Over	Switch		Switch I				
		One Time	Inhibit			One Time	Position		0 1				
Panic Mode Operation													
<i>Bind / I Button</i>													
Pressed = Panic Mode On													
Released = Panic Mode Off													

Installing the Flight Battery

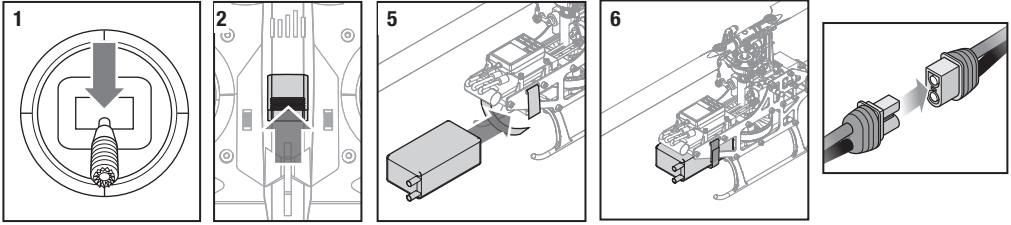

1. Lower the throttle stick to the lowest position.
2. Power ON the transmitter.
3. Center all trims.
4. Attach the hook material to the helicopter frame and the loop material to the flight battery.
5. Install the flight battery on the helicopter frame.
6. Secure the flight battery with the hook and loop strap.



CAUTION: Always disconnect the Li-Po battery from the aircraft when not flying to avoid over-discharging the battery. Batteries discharged to a voltage lower than the lowest approved voltage may become damaged, resulting in loss of performance and potential fire when batteries are charged.



WARNING: Always activate throttle hold and wait until the main rotor blades and tail rotor stop spinning before handling the model.

The throttle trim on the transmitter must remain at the center position. Raising the throttle trim above center may cause the main and tail motors to begin spinning.

NOTICE: If the flight battery hook and loop strap is pulled too tight, it may result in a vibration or the tail rotor may drift to the right during flight. If you experience either of these issues, loosen the strap slightly and fly again.



CAUTION: Connecting the battery to the ESC with reversed polarity will cause damage to the ESC, the battery or both. Damage caused by incorrectly connecting the battery is not covered under warranty.

If you experience issues during initialization, refer to the Troubleshooting Guide at the back of the manual.

LED Indicator on Flight Controller

LED Indicator on FC	Indicator Description
Red Flash and Orange Led Off	AR6251MHX waiting for transmitter connection, system will not initialize until connected
Yellow Flash	Calibrating
Slow Green Flash	Ready to Fly
Slow Red Flash	Failsafe Active
Red Solid and Yellow Flash	Calibration Error, FC not level or is being moved during calibration

Smart Throttle

Smart Throttle technology combines the throttle signal with telemetry data from the ESC on one normal three wire servo connector.

Smart Throttle ESCs can send current, voltage, ESC temp, and mAh consumed. Smart Throttle telemetry data shows up on your transmitter like any other telemetry sensor.

The ESC and receiver combination included with this aircraft is Smart compatible. An update for your transmitter may be required for Smart features.

(See www.spektrumrc.com to register and update your transmitter.)

To activate Smart Telemetry:

1. With the aircraft powered on after binding
2. Select the Telemetry screen; Settings; select Auto Config

To configure RPM information using Smart Telemetry:

3. After doing the initial Smart telemetry configuration keep the vehicle powered on
4. Select the Telemetry screen
5. Select Smart ESC and double select
6. Scroll down to NEXT
7. Enter the values for the magnetic pole count of the motor (24 pole) and the gear ratio (1:1)

When your transmitter is connected to a receiver sending Smart Data, the Smart Logo will appear under the battery logo on the home page and a signal bar will appear in the top left corner of the screen. Scrolling down, past the servo monitor, the Smart screen will appear.

Low Voltage Cutoff (LVC)

The ESC will continuously lower power to the motor until complete shutdown when the battery reaches 9V under load. This helps prevent over-discharge of the Li-Po battery. Land immediately when the ESC activates LVC. Continuing to fly after LVC can damage the battery, cause a crash or both. Crash damage and batteries damaged due to over-discharge are not covered under warranty.

Repeatedly flying the helicopter until LVC activates will damage the helicopter battery.

Disconnect and remove the Li-Po battery from the aircraft after use to prevent trickle discharge. During storage, make sure the battery charge does not fall below 3V per cell.

Transmitter and Receiver Binding



This product requires an approved Spektrum DSM2®/DSMX® compatible transmitter.

Visit www.bindnfly.com for a complete list of approved transmitters.

It is possible to bind this model with a bind plug or using the invert to bind method.

General Binding Procedure

1. Refer the Transmitter Setup Table to correctly setup your transmitter.
2. Lower the throttle stick to the lowest position. Set all trims to the center position.
3. Power off the transmitter RF and move all switches to the 0 position. Move the throttle to the low/off position.
4. Insert the bind plug into the receiver BIND/PROG port.
5. Connect the flight battery to the ESC. The LED on the receiver will flash when it enters bind mode.
6. Put the transmitter into bind mode.
7. Release the bind button/switch after 2–3 seconds. The helicopter is bound when the LED on the receiver turns solid.
8. Disconnect the flight battery and remove the bind plug.

Invert to Bind Procedure

1. Refer the Transmitter Setup Table to correctly setup your transmitter.
2. Lower the throttle stick to the lowest position. Set all trims to the center position.
3. Power off the transmitter RF and move all switches to the 0 position. Move the throttle to the low/off position.
4. Connect the flight battery to the ESC.
5. Flip the model upside down and hold for 15s. The LED on the receiver will flash when it enters bind mode.
6. Put the transmitter into bind mode. Release the bind button/switch after 2–3 seconds. The helicopter is bound when the LED on the receiver turns solid.
7. Disconnect the flight battery.

If you encounter problems, obey binding instructions and refer to the troubleshooting guide for other instructions. If needed, contact the appropriate Horizon Product Support office.



CAUTION: When using a Futaba® transmitter with a Spektrum™ DSM2® module, you must reverse the throttle channel and re-bind. Refer to your Spektrum module manual for binding and failsafe instructions.

Refer to your Futaba transmitter manual for instructions on reversing the throttle channel.

There are three flight modes programmed into the flight controller on this aircraft. The pilot can choose the level of stabilization needed to suit their skills and flying style. When needed, SAFE® (Sensor Assisted Flight Envelope) technology can level the aircraft and create a limited flight envelope.

SAFE technology delivers:

- Flight envelope protection you can select with the flight mode switch.
- Flight modes with features to suit all skill levels.

SAFE Technology in the flight controller is tuned for the Infusion 180.

Flight Mode and Rate Selection

Flight mode selection is made with Channel 5. When using the recommended transmitter settings Switch B will select the flight mode. The same switch also selects throttle and pitch curves designed to match the flight modes.

In **Stability Mode (switch position 0)** the bank angle is limited. When the cyclic stick is released the model will return to level. The head speed is set to a low rotor RPM and there is less negative collective pitch available. This mode is intended for taking off, landing, and first flights. Use high rates in this mode.

In **Intermediate Mode (switch position 1)** the bank angle is not limited. When the cyclic stick is released the model will not return to level. The head speed is set to a moderate rotor RPM and full collective pitch range is available. This mode is suitable for forward flight and basic aerobatics such as stall turns and loops.

Panic Recovery

Panic recovery is set to the I button with the recommended transmitter settings.

If you get into distress while flying in any mode, activate the panic function and move the control sticks to their neutral position. SAFE technology will immediately return the aircraft to an upright level attitude, if the aircraft is at a sufficient height with no obstacles in its path. Return the collective stick to 50% and deactivate the Panic Recovery Function to return to the current flight mode.

In **Agility Mode (switch position 2)** the bank angle is not limited. When the cyclic stick is released the model will not return to level. The head speed is set to a high rotor RPM and full collective pitch range is available. This mode is great for 3D aerobatics such as stationary flips and tic tocs.

Change rates in any mode by moving the two-position dual rate switch.

- Low rate reduces the control rates, providing an easier to fly model. Beginners should use low rate for initial flights.
- High rate provides full control and should be used by intermediate and experience pilots.

NOTICE: Before deactivating Panic Recovery, make sure the collective stick has been returned to the 50% position. Once the Panic Recovery has been deactivated, full negative collective becomes available, which could cause the Infusion 180 to descend rapidly.

- This mode is intended to provide the pilot with the confidence to continue to improve their flight skills.
- Move the collective stick to 50% and return all other transmitter controls to neutral for the quickest recovery.
- Once the model has reached a level upright attitude, the negative collective is reduced to prevent the user from pushing the model into the ground.

Throttle Hold

Throttle hold is used to prevent the motor from powering on inadvertently. For safety, turn throttle hold ON any time you need to touch the helicopter or check the direction controls. Throttle hold is also used to turn off the motor quickly if the

helicopter is out of control, in danger of crashing, or both. The blades will continue to spin briefly when throttle hold is activated.

Control Tests

Ensure the throttle hold is ON when doing the direction control tests. Test the controls prior to the first flight to ensure the servos, linkages and parts operate correctly. If the controls

do not react as shown in the illustrations below, confirm the transmitter is programmed correctly before continuing on to the Motor test.

TIP: To view the swashplate response in the rotor blades for aileron or elevator, rotate the rotor head and view the model from the rear or side as shown below.

Elevator

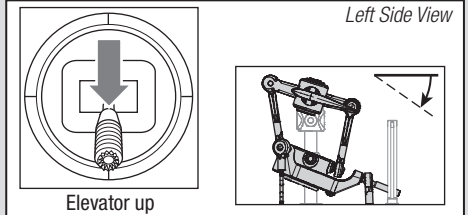
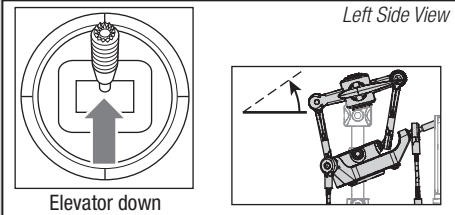

Aileron

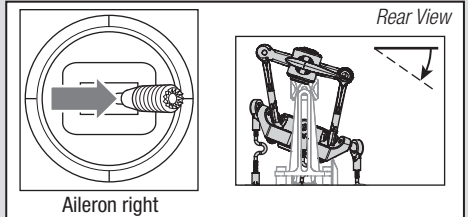
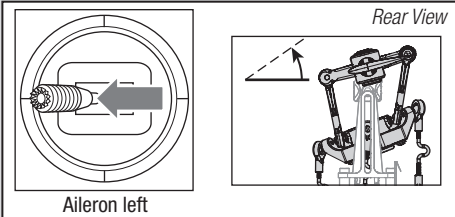

Collective Pitch

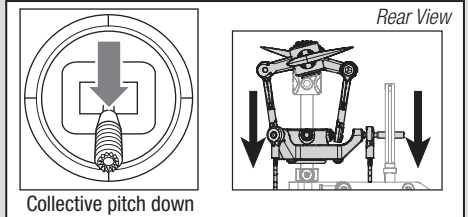
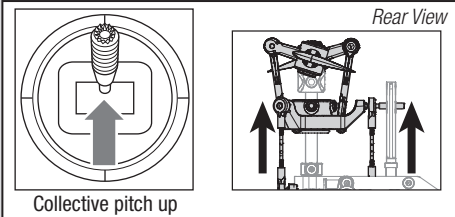

Motor

Place the helicopter outdoors on a clean, flat and level surface (concrete or asphalt) free of obstructions. Always stay clear of moving rotor blades.



CAUTION: Keep pets and other animals away from the helicopter. Animals may injure themselves if they attack or run toward the helicopter.

1. Confirm that throttle is at full low position.
2. Turn Throttle Hold OFF.



WARNING: Stay at least 30 feet (10 meters) away from the helicopter when the motor is running. Do not attempt to fly the helicopter at this time.

3. Slowly increase the throttle until the blades begin to spin. The main blades should spin clockwise when viewing the helicopter from the top. The tail rotor blades should spin counterclockwise when viewing the helicopter from the right side.

NOTICE: If the main rotor blades are spinning counterclockwise, reduce the throttle to low immediately. Disconnect the battery from the helicopter and reverse any two motor wire connections to the ESC and repeat the motor control test.

Understanding the Primary Flight Controls

If you are not familiar with the controls of your aircraft, take a few minutes to familiarize yourself with them before attempting your first flight.

Collective

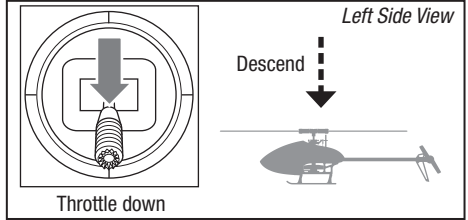
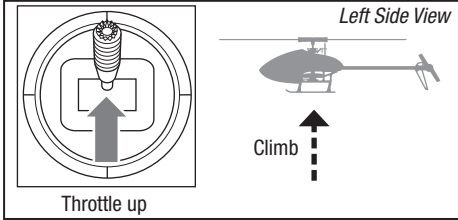

Rudder

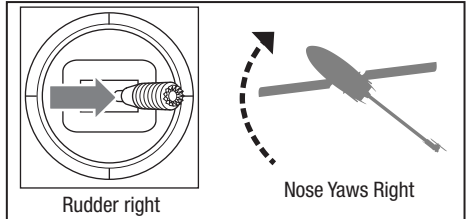
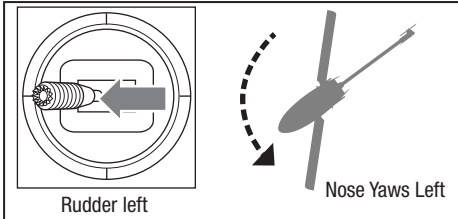

Elevator

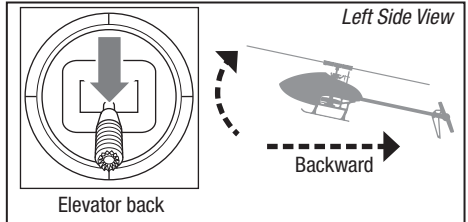
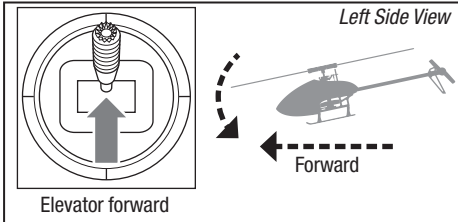

Aileron

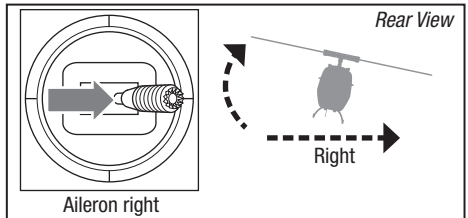
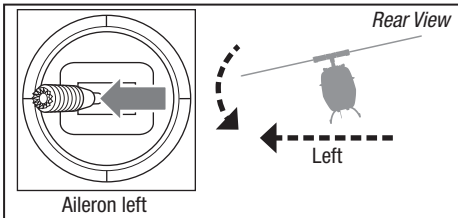

Flying the Infusion 180

Consult your local laws and ordinances before choosing a location to fly your aircraft.

We recommend flying your aircraft outside in calm winds or inside a large gymnasium. Always avoid flying near houses, trees, wires and buildings. You should also be careful to avoid flying in areas where there are many people, such as busy parks, schoolyards or soccer fields.

It is best to fly from a smooth flat surface as this will allow the model to slide without tipping over. Keep the helicopter approximately 2 ft (600mm) above the ground. Keep the tail pointed toward you during initial flights to keep the control orientation consistent. Releasing the stick in Stability Mode will allow the helicopter to level itself. Activating the Panic Recovery button will level the helicopter quickly. If you become disoriented while in Stability Mode, slowly lower the throttle stick to land softly.

During initial flights, only attempt takeoff, landing and hovering in one spot.

Takeoff

NOTICE: If the main motor or tail motor do not start up properly when throttle is first applied, immediately return the throttle to the low position and try again. If the problem persists, disconnect the flight battery, check for smooth motor operation and ensure no wires have become entangled or are rubbing on the motors.

Place the model onto a flat, level surface free of obstacles and walk back 30 feet (10 meters). Slowly increase the throttle until the model is approximately 2 ft. (600mm) off the ground and begin flying the model.

Hovering

Making small corrections on the transmitter, try to hold the helicopter in one spot. If flying in calm winds, the model should require almost no corrective inputs. After moving the cyclic stick and returning it to center, the model should level itself. The model may continue to move due to inertia. Move the cycle stick in the opposite direction to stop the movement.

After you become comfortable hovering, you can progress into flying the model to different locations, keeping the tail pointed towards you at all times. You can also ascend and descend using the throttle stick. Once you're comfortable with these maneuvers, you can attempt flying with the tail in different orientations. It is important to keep in mind that the flight control inputs will rotate with the helicopter, so always try to picture the control inputs relative to the nose of the helicopter. For example, forward will always drop the nose of the helicopter.

Low Voltage Cutoff (LVC)

LVC decreases the power to the motors when the battery voltage gets low. When the motor power decreases and the red LED on the ESC flashes, land the aircraft immediately and recharge the flight battery.

LVC does not prevent the battery from over-discharge during storage.

NOTICE: Repeated flying to LVC will damage the battery.

Landing

To land, slowly decrease the throttle while in a low-level hover. After landing, disconnect and remove the battery from the aircraft after use to prevent trickle discharge. Review your manufacturers provided LiPo guidelines for charging and storage information.

Advanced Tuning (Forward Programming)

Applies to forward programming capable Spektrum Transmitters including DX6e, DX8e, DX6G2, DX7G2, DX8G2, DX9, iX12, DX18, iX20, DX20, NX6, NX8, NX10

The Infusion 180 default settings are appropriate for most users. We recommend flying with the default parameters before making any adjustments.

The Infusion 180 BNF flight controller may be programmed from any compatible Spektrum transmitter (visit SpektrumRC.com for more information).

The flight controller shipped with BNF models has a range of adjustable parameters suitable for the Infusion 180 Helicopter and is not intended for use in other aircraft.

It is important to use the included servos with the BNF flight controller because the adjustable parameters available for the SPMAR6251MHX are designed around the recommended servos. It is possible there may not be enough range for the helicopter to be tuned when using alternative servos.

Entering the Advanced Parameters Menu

With the helicopter bound to the transmitter and powered on, enter the Function List and select Forward Programming. The list of adjustable parameters and the range of values available for tuning have been tailored for this helicopter. Make small changes to one parameter at a time and test fly the changes before changing the parameter further or changing a different parameter.

Calibration Procedure:

If the helicopter is experiencing drift issues, perform the following calibration. The calibration procedure may also be needed following crash repairs.

1. Ensure the surface used for calibration is level.
2. Power on the transmitter and activate throttle hold.
3. Connect the flight batter to the ESC and allowing the model to initialize.
4. Turn Throttle Hold ON.
5. Using a bubble level as shown below, level the helicopter by placing a shim under the landing skid.
6. Enter the Function List on your transmitter.
7. Select Forward Programming.
8. Select System Setup.
9. Select Calibration.
10. Select Apply and the calibration will begin. The LED will flash yellow indicating the calibration is proceeding normally. If the LED changes to red this indicates the model is not near level or the model was moved, in this case the calibration starts over.
11. After the calibration is successfully completed, the receiver LED will change to a slow cyan flash which indicates the calibration has completed.
12. Proceed to the pre-flight check list procedure before flying your model.

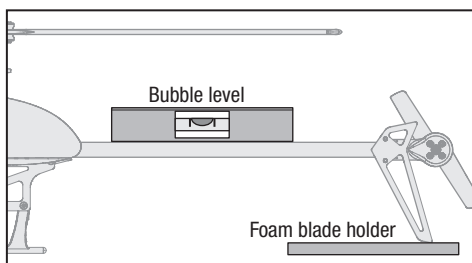

Factory Reset

If the process of tuning the Infusion 180 helicopter results in undesirable flight performance, you can reset the settings back to factory defaults by selecting the Factory Reset option in Forward Programming.

1. Enter the Function List
2. Select Forward Programming
3. Select System Setup
4. Select Factory Reset
5. Select Apply
6. Perform the Setup->Swashplate->Sub Trim function and ensure the servos are properly trimmed.
7. Proceed with the pre-flight check list procedure before flying the model.

Advanced Tuning (Non-Forward Programming)

Applies to Spektrum transmitters not capable of forward programming including DX6i, DX6e, DX7s DX8, and DX8e

Your Blade Infusion 180 was setup at the factory and test flown. The servo adjustment steps are usually only necessary in special circumstances, such as after a crash or if a servo or linkage is replaced.

For pilots flying with a transmitter not capable of forward programming use the following procedures to make servo adjustments and perform the calibration procedure.

The advanced tuning options must be entered within 30 seconds after initialization completes. In addition the combination of dual rates and travel adjustments must result in a throw greater than 65% in order to enter the tuning modes.

Entering Servo Adjustment Mode

1. Lower the throttle stick to the lowest position.
2. Power ON the transmitter and activate throttle hold.
3. Install the flight battery on the helicopter frame, securing it with the hook and loop strap.
4. Connect the battery connector to the ESC.
5. After initialization is complete (indicated by a slow green

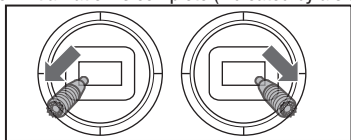

flash), hold the left stick to the bottom left corner and the right stick to the bottom right corner as shown.

6. Servo Adjustment Mode is indicated by the swashplate servos jumping and then slowly moving back to center.
7. Release the sticks and proceed to the next step.

Adjusting the Servo Neutral Position

With the model in Servo Adjustment Mode, the control stick and gyro inputs are disabled and the servos are held in the neutral position. Check the position of the servo arms to verify they are perpendicular to the servos.

- If the arms are perpendicular to the servos, no adjustment is necessary. Exit Servo Adjustment Mode.
- If one or more servo arm is not perpendicular to the servos, continue the servo adjustment process.

While watching the swashplate servos, apply fore or aft cyclic and release. One of the servos will jump, indicating the selected servo. Apply fore or aft cyclic and release until the servo that needs to be adjusted is selected.

Once the servo you wish to adjust is selected, move the cyclic stick left or right to adjust the servo neutral position in the desired direction.

To reset the current servo to the default neutral position, hold the rudder stick full right for two seconds.

The range of adjustment is limited. If you are unable to adjust the servo arm to be perpendicular to the servo, you must reset the servo to the default neutral position, remove the servo arm and place it back onto the servo as close to perpendicular as possible. You may then adjust the servo neutral position using left or right cyclic stick.

Swashplate Leveling

Before saving your adjustments and exiting servo adjustment mode, verify the swashplate is level and both main rotor blades are at 0 degrees pitch.

If they are not, make linkage adjustments as necessary.

Saving the Servo Adjustments

1. Lower the throttle stick to the lowest position and release the sticks.
2. Move the tail rotor stick to the left and hold for four seconds to exit Servo Adjustment Mode. The servos will jump indicating a return to normal operation.
3. Release the tail rotor stick.
4. Perform the pre-flight checklist procedure before flying your model.

Control Input in Servo Adjustment Mode	Action in Servo Adjustment Mode
Fore/Aft Cyclic	Select Previous or Next Servo
Right/Left Cyclic	Increase or Decrease Sub Trim Adjustment
Right Tailrotor	Hold For Two Seconds; Neutral Position is Reset on Selected Servo
Left Tailrotor and Low throttle	Hold for Four Seconds; Exit Servo Adjustment mode

Trim Flight

Perform this procedure if the model is not performing well or has been recently rebuilt from a crash.

The trim flight procedure was performed during the factory test flight and only needs to be performed if you notice the model is not returning to level consistently or if the model does not remain still during stationary pirouettes.

Performing the Trim Flight

1. Slowly increase the throttle to lift the model into a stationary hover. Make corrections as necessary to keep the model still. Evaluation does not begin until the throttle stick is over 50% and the sticks are centered. Making corrections will not affect the result but a longer flight may be necessary.
2. Keep the model stationary in a hover for 120 seconds. Sliding and slow movements are okay. The main goal is to keep the rotor disk level.
3. Once you are satisfied with the trim flight, land the model.

Exiting Trim Flight Mode

1. After landing, lower the throttle stick to the lowest position.
2. Activate Panic Recovery for 2 seconds, or until the swashplate moves, indicating the servo positions and attitude values have been recorded and trim flight mode has been exited.

Calibration Procedure (Non-Forward Programming)

If the Blade Infusion 180 is experiencing drift issues after completing the trim flight procedure located at www.bladehelis.com, perform the following calibration. The calibration procedure may also be needed following crash repairs.



WARNING: Before beginning the calibration procedure, disconnect the main motor and tail motor leads to prevent accidental motor startup during calibration.

To perform the calibration procedure:

1. Ensure the surface used for calibration is level.
2. Power on the transmitter and helicopter, allowing them to initialize.
3. Turn Throttle Hold ON.
4. **Ensure the main motor and tail motor leads are disconnected.** Set the flight mode switch to Intermediate Mode (FM1).
5. Using a bubble level as shown below, level the helicopter by placing the Blade Infusion 180 foam blade holder under the tail fin. Use additional items, as necessary, to build up under the tail fin until the tail boom is level.

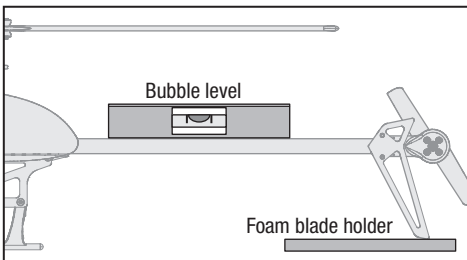

The trim flight is used to determine the optimal settings for SAFE® technology during flight.

The trim flight must be performed in calm conditions.

Flight Test

After performing the trim flight, test-fly the model to evaluate the leveling characteristics.

- The model should return to level flight consistently.
- During takeoff, the model should lift off with minimal corrections.
- During a hover, the control stick should remain close to center. Small corrections are acceptable.

If the model performs poorly or does not level properly after the trim flight, retry the entire trim flight procedure. If the problem persists, inspect the model for damaged components, a bent shaft or anything that may result in increased vibration. The trim flight may not record the correct values due to excessive vibration, flying in wind or the model not staying level. In these cases, shorter trim flights may be necessary. If you are still experiencing problems after several attempts please perform the calibration procedure and try the trim flight procedure again.

6. Hold the left stick to the bottom right corner, the right stick to the upper left corner and activate the Panic Recovery function until the LED on the receiver flashes once.

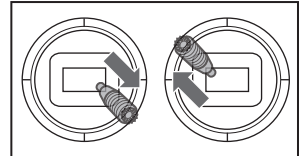

7. Release both sticks and deactivate the Panic Recovery function.
8. The LED on the receiver will remain solid for 1-2 minutes while the calibration takes place. Do not move the helicopter until the calibration is completed. If the LED begins blinking rapidly, an error has occurred. Begin the calibration procedure again, starting with step 1.
9. After the calibration is successfully completed, the receiver LED will blink slowly (2 seconds on, 2 seconds off).
10. Power the helicopter off.
11. Reconnect the main motor and tail motor wires.
12. Perform the trim flight procedure.
13. During subsequent flights after the trim flight, the helicopter should return to within 5 degrees of level consistently.

Post-Flight Inspection and Maintenance Checklist

✓		
Ball Links	Make sure the plastic ball link holds the control ball, but is not tight (binding) on the ball. When a link is too loose on the ball, it can separate from the ball during flight and cause a crash. Replace worn ball links before they fail.	
Cleaning	Make sure the battery is not connected before cleaning. Remove dust and debris with a soft brush or a dry, lint-free cloth.	
Bearings	Replace bearings when they become notchy (sticky in places when turning) or draggy.	
Wiring	Make sure the wiring does not contact moving parts. Replace damaged wiring and loose connectors.	
Fasteners	Make sure there are no loose screws, other fasteners or connectors. Do not over-tighten metal screws in plastic parts. Tighten screws so the parts are mated together, then turn the screw only 1/8th of a turn more.	
Rotors	Make sure there is no damage to rotor blades and other parts which move at high speed. Damage to these parts includes cracks, burrs, chips or scratches. Replace damaged parts before flying. Verify both main rotor blades have the correct and equal tension in the blade grips. When the helicopter is held up sideways, the main blades should support their own weight. When the helicopter is shaken lightly, the blades should fall.	
Tail	Inspect the tail rotor for damage and replace if necessary. Verify the tail motor bolts, tail rotor adapter bolts and tail motor mount bolts are properly tightened. Inspect the tail boom for any damage and replace if necessary.	
Mechanics	Inspect the main frame and landing gear for damage and replace if necessary. Check the mainshaft for vertical play and adjust the locking collar if necessary. Inspect all wires for damage and replace as necessary.	

Troubleshooting Guide

Problem	Possible Cause	Solution
Helicopter control response is inconsistent or requires extra trim to neutralize movement	Aircraft was not initialized properly or a vibration is interfering with the sensor operation	Disconnect the flight battery, center the control trim and re-initialize the helicopter
Helicopter will not respond to throttle	Throttle too high and/or throttle trim is too high	Disconnect the flight battery, place the throttle stick in the lowest position and move the throttle trim to the center position. Connect the flight battery and allow the model to initialize
	Helicopter moved during initialization	Disconnect the flight battery and re-initialize the helicopter while keeping the helicopter from moving
Helicopter has reduced flight time or is underpowered	Flight battery charge is low	Completely recharge the flight battery
	Flight battery is damaged	Replace the flight battery and follow the flight battery instructions
	Flight conditions might be too cold	Make sure the battery is warm (room temperature) before use
LED on receiver flashes rapidly and aircraft will not respond to transmitter (during binding)	Transmitter too near aircraft during binding process	Power off the transmitter. Move the transmitter a larger distance from the aircraft. Disconnect and reconnect the flight battery to the aircraft. Follow the binding instructions
	Bind switch or button was not held while transmitter was powered on	Power off transmitter and repeat bind process
	Aircraft or transmitter is too close to large metal object, wireless source or another transmitter	Move aircraft and transmitter to another location and attempt binding again

Problem	Possible Cause	Solution
LED on the receiver flashes rapidly and the helicopter will not respond to the transmitter (after binding)	The bind plug was not removed from the receiver after binding	Disconnect the flight battery, remove the bind plug from the receiver and reconnect the flight battery.
	Less than a 5-second wait between first powering on the transmitter and connecting the flight battery to the helicopter	Leave the transmitter powered on. Disconnect and reconnect the flight battery to the helicopter
	The helicopter is bound to a different model memory (ModelMatch™ transmitters only)	Select the correct model memory on the transmitter. Disconnect and reconnect the flight battery to the helicopter
	Flight battery or transmitter battery charge is too low	Replace or recharge batteries
	Aircraft or transmitter is too close to large metal object, wireless source or another transmitter	Move aircraft and transmitter to another location and attempt connecting again
Helicopter vibrates or shakes in flight	Damaged rotor blades, spindle or blade grips	Check main rotor blades and blade grips for cracks or chips. Replace damaged parts. Replace bent spindle
Random movements in flight	Vibration	Verify the receiver is properly attached to the helicopter. Inspect mounting tape for damage. Verify that no wires are contacting the receiver. Inspect and balance all rotating components. Verify the main shaft and tail rotor adapter are not damaged or bent. Inspect mechanics for broken or damaged parts and replace as necessary
Tail oscillation/wag or poor performance	Damaged tail rotor, loose bolts, vibration	Verify that the boom support bolts are tight and the plastic boom support ends are properly adhered to the boom support rods. Inspect the tail rotor for damage. Verify that all bolts on the tail assembly are properly tightened. V Replace any damaged or worn components
Drift in calm winds	Vibration, damaged linkage, damaged servo	Under normal operation the transmitter trims should not require adjustment and the center positions are memorized during initialization. If you find that trim adjustments are necessary after take off, verify the balance of all rotating components, ensure the linkages are not damaged and make sure the servos are in proper working condition
Drift in wind	Normal	The model will drift with the wind but should remain level in flight. Simply hold the cyclic stick in the necessary position to keep the model stationary. The model must lean into the wind to remain stationary, if the model remains level then it will drift with the wind
Panic Recovery or Return to Level does not level the model	Model was not initialized on a level, still surface	Re-initialize the model on a level and still surface
	Model was not taken off of a level surface	Always lift off from a level surface
Severe vibration	Battery strapped too tightly to the model	Loosen the battery strap
	Rotating component out of balance	Check the main shaft, tail rotor, main rotor blades, main frame and adapter for damage, replace as necessary. Vibration must be minimized for Panic Recovery and Return to Level functions to work properly

Exploded View

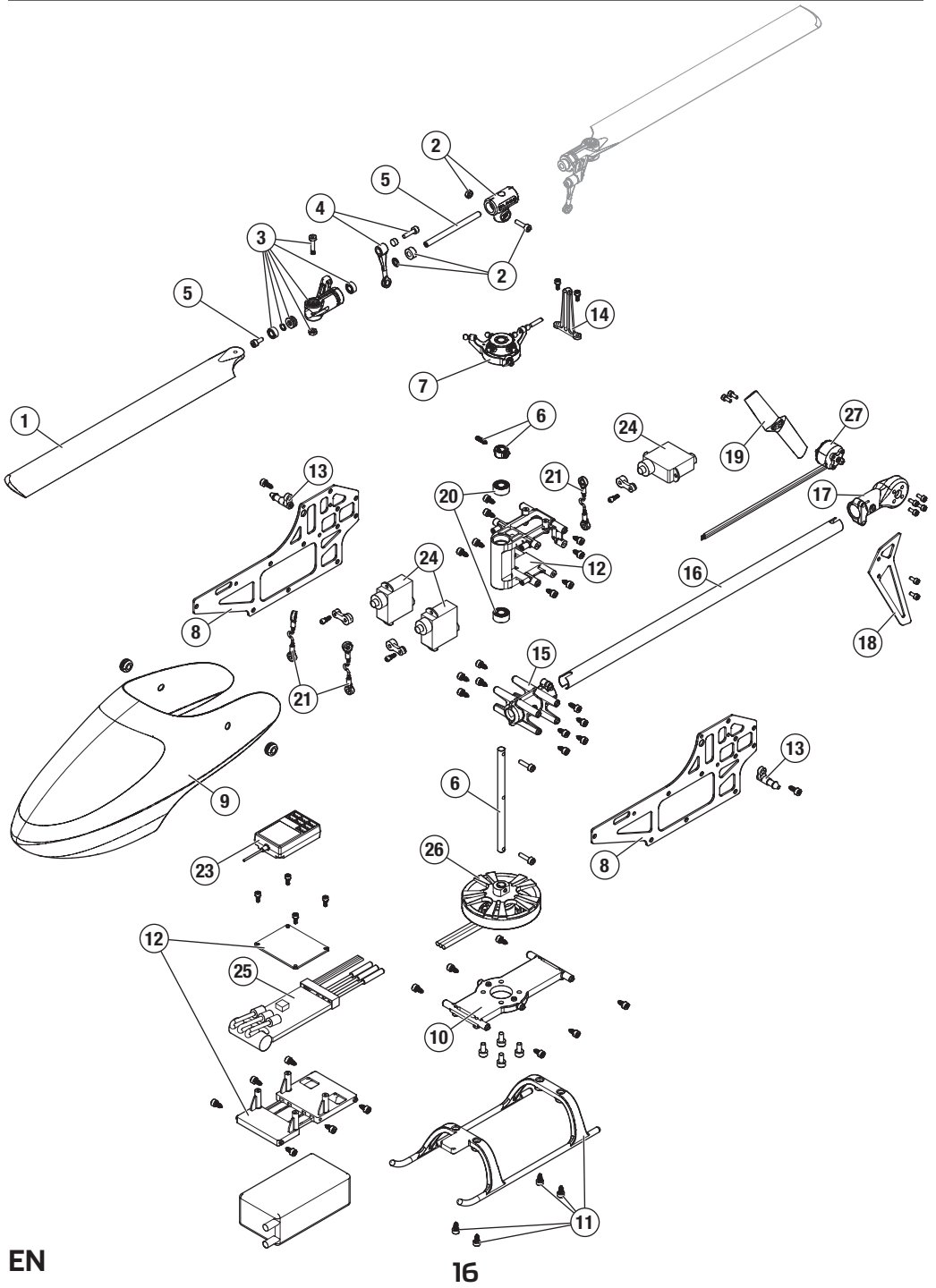

Parts Listings

Part #	Description
1	BLH7001 180mm Main Blade Set: Infusion
2	BLH7002 Main Rotor Headblock: Infusion
3	BLH7003 Main Blade Grips: Infusion 180
4	BLH7004 FBL Links: Infusion 180
5	BLH7005 Spindle (2): Infusion 180
6	BLH7006 Main Shaft: Infusion 180
7	BLH7007 Washplate: Infusion 180
8	BLH7008 Carbon Frame (1): Infusion 180
9	BLH7009 Canopy: Infusion 180
10	BLH7010 Landing Gear Mount: Infusion 180
11	BLH7011 Landing Gear: Infusion 180
12	BLH7012 Main Mounting Plate: Infusion 180
13	BLH7013 Body Posts: Infusion 180
14	BLH7014 Anti-Rotation Bracket: Infusion

Part #	Description
15	BLH7015 Front Tail Boom Mount: Infusion 180
16	BLH7016 Tail Boom (2): Infusion 180
17	BLH7017 Tail Motor Mount: Infusion 180
18	BLH7018 Vertical Tail Fin: Infusion 180
19	BLH7019 Tail Prop (2): Infusion 180
20	BLH7020 Radial Bearing: 4x9x4mm
21	BLH7021 Pushrod Set (3): Infusion 180
22	BLH7022 Ball and Link Set: Infusion 180
23	SPMAR6251MHX Infusion 180 AS3X@/ Smart@ receiver
24	SPMSH2080 12g MG Heli Cyclic Servo
25	SPMXAE1020A Brushless ESC: Infusion 180
26	SPMXHM1005 4004 - 650Kv Brushless Main Motor
27	SPMXHM1010 1104-5500Kv Brushless Tail Motor

Optional Parts

Part #	Description
SPMX6003S50	600mAh 3S 11.1V Smart G2 50C; IC2
SPMXCA320	Adapter: IC3 Batt / IC2 Dev 6
SPMXC1080	Smart S 1100 AC Charger, 1x100W

Limited Warranty

What this Warranty Covers

Horizon Hobby, LLC, (Horizon) warrants to the original purchaser that the product purchased (the "Product") will be free from defects in materials and workmanship at the date of purchase.

What is Not Covered

This warranty is not transferable and does not cover (i) cosmetic damage, (ii) damage due to acts of God, accident, misuse, abuse, negligence, commercial use, or due to improper use, installation, operation or maintenance, (iii) modification of or to any part of the Product, (iv) attempted service by anyone other than a Horizon Hobby authorized service center, (v) Product not purchased from an authorized Horizon dealer, (vi) Product not compliant with applicable technical regulations, or (vii) use that violates any applicable laws, rules, or regulations.

OTHER THAN THE EXPRESS WARRANTY ABOVE, HORIZON MAKES NO OTHER WARRANTY OR REPRESENTATION, AND HEREBY DISCLAIMS ANY AND ALL IMPLIED WARRANTIES, INCLUDING, WITHOUT LIMITATION, THE IMPLIED WARRANTIES OF NON-INFRINGEMENT, MERCHANTABILITY AND FITNESS FOR A PARTICULAR PURPOSE. THE PURCHASER ACKNOWLEDGES THAT THEY ALONE HAVE DETERMINED THAT THE PRODUCT WILL SUITABLY MEET THE REQUIREMENTS OF THE PURCHASER'S INTENDED USE.

Purchaser's Remedy

Horizon's sole obligation and purchaser's sole and exclusive remedy shall be that Horizon will, at its option, either (i) service, or (ii) replace, any Product determined by Horizon to be defective. Horizon reserves the right to inspect any and all Product(s)

involved in a warranty claim. Service or replacement decisions are at the sole discretion of Horizon. Proof of purchase is required for all warranty claims. SERVICE OR REPLACEMENT AS PROVIDED UNDER THIS WARRANTY IS THE PURCHASER'S SOLE AND EXCLUSIVE REMEDY.

Limitation of Liability

HORIZON SHALL NOT BE LIABLE FOR SPECIAL, INDIRECT, INCIDENTAL OR CONSEQUENTIAL DAMAGES, LOSS OF PROFITS OR PRODUCTION OR COMMERCIAL LOSS IN ANY WAY, REGARDLESS OF WHETHER SUCH CLAIM IS BASED IN CONTRACT, WARRANTY, TORT, NEGLIGENCE, STRICT LIABILITY OR ANY OTHER THEORY OF LIABILITY, EVEN IF HORIZON HAS BEEN ADVISED OF THE POSSIBILITY OF SUCH DAMAGES. Further, in no event shall the liability of Horizon exceed the individual price of the Product on which liability is asserted. As Horizon has no control over use, setup, final assembly, modification or misuse, no liability shall be assumed nor accepted for any resulting damage or injury. By the act of use, setup or assembly, the user accepts all resulting liability. If you as the purchaser or user are not prepared to accept the liability associated with the use of the Product, purchaser is advised to return the Product immediately in new and unused condition to the place of purchase.

Law

These terms are governed by Illinois law (without regard to conflict of law principals). This warranty gives you specific legal rights, and you may also have other rights which vary from state to state. Horizon reserves the right to change or modify this warranty at any time without notice.

WARRANTY SERVICES

Questions, Assistance, and Services

Your local hobby store and/or place of purchase cannot provide warranty support or service. Once assembly, setup or use of the Product has been started, you must contact your local distributor or Horizon directly. This will enable Horizon to better answer your questions and service you in the event that you may need any assistance. For questions or assistance, please visit our website at www.horizonhobby.com, submit a Product Support Inquiry, or call the toll free telephone number referenced in the Warranty and Service Contact Information section to speak with a Product Support representative.

Inspection or Services

If this Product needs to be inspected or serviced and is compliant in the country you live and use the Product in, please use the Horizon Online Service Request submission process found on our website or call Horizon to obtain a Return Merchandise Authorization (RMA) number. Pack the Product securely using a shipping carton. Please note that original boxes may be included, but are not designed to withstand the rigors of shipping without additional protection. Ship via a carrier that provides tracking and insurance for lost or damaged parcels, as Horizon is not responsible for merchandise until it arrives and is accepted at our facility. An Online Service Request is available at http://www.horizonhobby.com/content/_service-center_render-service-center. If you do not have internet access, please contact Horizon Product Support to obtain a RMA number along with instructions for submitting your product for service. When calling Horizon, you will be asked to provide your complete name, street address, email address and phone number where you can be reached during business hours. When sending product into Horizon, please include your RMA number, a list of the included items, and a brief summary of the problem. A copy of your original sales receipt must be included for warranty consideration. Be sure your name, address, and RMA number are clearly written on the outside of the shipping carton.

NOTICE: Do not ship Li-Po batteries to Horizon. If you have any issue with a Li-Po battery, please contact the appropriate Horizon Product Support office.

Warranty Requirements

For Warranty consideration, you must include your original sales receipt verifying the proof-of-purchase date. Provided warranty conditions have been met, your Product will be serviced or replaced free of charge. Service or replacement decisions are at the sole discretion of Horizon.

Non-Warranty Service

Should your service not be covered by warranty, service will be completed and payment will be required without notification or estimate of the expense unless the expense exceeds 50% of the retail purchase cost. By submitting the item for service you are agreeing to payment of the service without notification. Service estimates are available upon request. You must include this request with your item submitted for service. Non-warranty service estimates will be billed a minimum of ½ hour of labor. In addition you will be billed for return freight. Horizon accepts money orders and cashier's checks, as well as Visa, MasterCard, American Express, and Discover cards. By submitting any item to Horizon for service, you are agreeing to Horizon's Terms and Conditions found on our website http://www.horizonhobby.com/content/_service-center_render-service-center.

ATTENTION: Horizon service is limited to Product compliant in the country of use and ownership. If received, a non-compliant Product will not be serviced. Further, the sender will be responsible for arranging return shipment of the un-serviced Product, through a carrier of the sender's choice and at the sender's expense. Horizon will hold non-compliant Product for a period of 60 days from notification, after which it will be discarded.

10/15

Warranty and Service Contact Information

Country of Purchase	Horizon Hobby	Contact Information	Address
United States of America	Horizon Service Center (Repairs and Repair Requests)	servicecenter.horizonhobby.com/RequestForm/	2904 Research Rd Champaign, Illinois, 61822 USA
	Horizon Product Support (Product Technical Assistance)	productsupport@horizonhobby.com 877-504-0233	
	Sales	websales@horizonhobby.com 800-338-4639	
European Union	Horizon Technischer Service Sales: Horizon Hobby GmbH	service@horizonhobby.eu +49 (0) 4121 2655 100	Hanskampring 9 D 22885 Barsbüttel, Germany

FCC Information

Contains FCC ID: BRWWAC01T

This equipment complies with FCC and IC radiation exposure limits set forth for an uncontrolled environment. This equipment should be installed and operated with minimum distance 20cm between the radiator and/or antenna and your body (excluding fingers, hands, wrists, ankles and feet). This transmitter must not be co-located or operating in conjunction with any other antenna or transmitter.

Supplier's Declaration of Conformity

BLH Infusion 180 BNF (BLH7050)

Contains FCC ID: BRWWAC01T

This equipment complies with FCC and IC radiation exposure limits set forth for an uncontrolled environment. This equipment should be installed and operated with minimum distance 20cm between the radiator and/or antenna and your body (excluding fingers, hands, wrists, ankles and feet). This transmitter must not be co-located or operating in conjunction with any other antenna or transmitter.

Supplier's Declaration of Conformity

 This device complies with part 15 of the FCC Rules. Operation is subject to the following two conditions: (1) This device may not cause harmful interference, and (2) this device must accept any interference received, including interference that may cause undesired operation.



CAUTION: Changes or modifications not expressly approved by the party responsible for compliance could void the user's authority to operate the equipment.

NOTE: This equipment has been tested and found to comply with the limits for a Class B digital device, pursuant to part 15 of the FCC Rules. These limits are designed to provide reasonable protection against harmful interference in a residential installation. This equipment generates, uses and can radiate radio frequency energy and, if not installed and used in accordance with the instructions, may cause harmful interference to radio communications. However, there is no guarantee that interference will not occur in a particular

installation. If this equipment does cause harmful interference to radio or television reception, which can be determined by turning the equipment off and on, the user is encouraged to try to correct the interference by one or more of the following measures:

- Reorient or relocate the receiving antenna.
- Increase the separation between the equipment and receiver.
- Connect the equipment into an outlet on a circuit different from that to which the receiver is connected.
- Consult the dealer or an experienced radio/TV technician for help.

Horizon Hobby, LLC
2904 Research Rd.,
Champaign, IL 61822
Email: compliance@horizonhobby.com
Web: HorizonHobby.com

IC Information

CAN ICES-3 (B)/NMB-3(B)

Contains IC: 6157A-WAC01T

This device contains license-exempt transmitter(s)/receivers(s) that comply with Innovation, Science, and Economic Development Canada's license-exempt RSS(s). Operation is subject to the following 2 conditions:

1. This device may not cause interference.
2. This device must accept any interference, including interference that may cause undesired operation of the device.

Compliance Information for the European Union



EU Compliance Statement:

BLH Infusion 180 BNF (BLH7050); Hereby, Horizon Hobby, LLC declares that the device is in compliance with the following: EU Radio Equipment Directive 2014/53/EU, RoHS 2 Directive 2011/65/EU, RoHS 3 Directive - Amending 2011/65/EU Annex II 2015/863

NOTE: This product contains batteries that are covered under the 2006/66/EC European Directive, which cannot be disposed of with normal household waste. Please follow local regulations.

The full text of the EU declaration of conformity is available at the following internet address: <https://www.horizonhobby.com/content/support-render-compliance>.

Wireless Frequency Range and Wireless Output Power:
6157A-WAC01T

2402 – 2478 MHz
1.43dBm

WEEE NOTICE:



This appliance is labeled in accordance with European Directive 2012/19/EU concerning waste of electrical and electronic equipment (WEEE). This label indicates that this product should not be disposed of with household waste. It should be deposited at an appropriate facility to enable recovery and recycling.

EU Manufacturer of Record:

Horizon Hobby, LLC
2904 Research Road
Champaign, IL 61822 USA

EU Importer of Record:

Horizon Hobby, GmbH
Hanskampring 9
22885 Barsbüttel Germany

Australia/New Zealand:



E328

EN



©2021 Horizon Hobby, LLC.

Blade, the Blade logo, E-flite, BNF, the BNF logo, DSM, DSM2, DSMX, SAFE, the SAFE logo, Spektrum AirWare and ModelMatch are trademarks or registered trademarks of Horizon Hobby, LLC.

The Spektrum trademark is used with permission of Bachmann Industries, Inc.

All other trademarks, service marks and logos are property of their respective owners.

US 9,930,567. US 10,419,970. Other patents pending.

Created 11/21

164694

BLH7050