

HORIZON[®]
H O B B Y

Eflite[®]
ADVANCING ELECTRIC FLIGHT

UMX[™] Citation Longitude 30mm EDF Twin

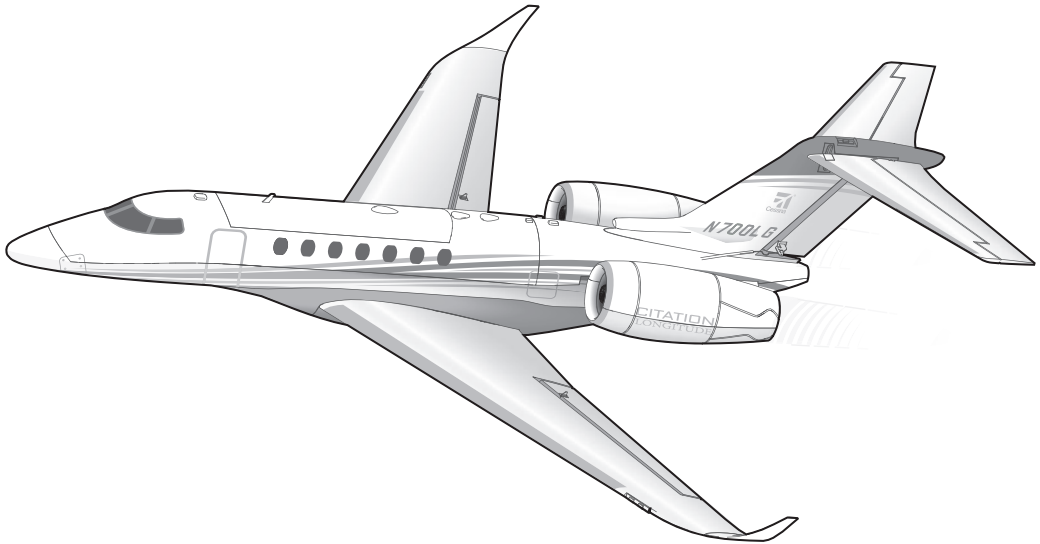

*Instruction Manual
Bedienungsanleitung
Manuel d'utilisation
Manuale di Istruzioni*

SAFE[®]

SAFE[®] Select Technology, Optional Flight Envelope Protection

AS3X[®]

BNF[®]
BASIC

NOTICE

All instructions, warranties and other collateral documents are subject to change at the sole discretion of Horizon Hobby, LLC. For up-to-date product literature, visit horizonhobby.com or towerhobbies.com and click on the support or resources tab for this product.

Meaning of Special Language:

The following terms are used throughout the product literature to indicate various levels of potential harm when operating this product:

WARNING: Procedures, which if not properly followed, create the probability of property damage, collateral damage, and serious injury OR create a high probability of superficial injury.

CAUTION: Procedures, which if not properly followed, create the probability of physical property damage AND a possibility of serious injury.

NOTICE: Procedures, which if not properly followed, create a possibility of physical property damage AND little or no possibility of injury.

 **WARNING:** Read the ENTIRE instruction manual to become familiar with the features of the product before operating. Failure to operate the product correctly can result in damage to the product, personal property and cause serious injury.

This is a sophisticated hobby product. It must be operated with caution and common sense and requires some basic mechanical ability. Failure to operate this product in a safe and responsible manner could result in injury or damage to the product or other property. This product is not intended for use by children without direct adult supervision. Do not use with incompatible components or alter this product in any way outside of the instructions provided by Horizon Hobby, LLC. This manual contains instructions for safety, operation and maintenance. It is essential to read and follow all the instructions and warnings in the manual, prior to assembly, setup or use, in order to operate correctly and avoid damage or serious injury.

Age Recommendation: Not for children under 14 years. This is not a toy.

Safety Precautions and Warnings

- Always keep a safe distance in all directions around your model to avoid collisions or injury. This model is controlled by a radio signal subject to interference from many sources outside your control. Interference can cause momentary loss of control.
- Always operate your model in open spaces away from full-size vehicles, traffic and people.
- Always carefully follow the directions and warnings for this and any optional support equipment (chargers, rechargeable battery packs, etc.).
- Always keep all chemicals, small parts and anything electrical out of the reach of children.
- Always avoid water exposure to all equipment not specifically designed and protected for this purpose. Moisture causes damage to electronics.
- Never place any portion of the model in your mouth as it could cause serious injury or even death.
- Never operate your model with low transmitter batteries.
- Always keep aircraft in sight and under control.
- Always use fully charged batteries.
- Always keep the transmitter powered on while aircraft is powered.
- Always remove batteries before disassembly.
- Always keep moving parts clean.
- Always keep parts dry.
- Always let parts cool after use before touching.
- Always remove batteries after use.
- Always ensure failsafe is properly set before flying.
- Never operate aircraft with damaged wiring.
- Never touch moving parts.

 **WARNING AGAINST COUNTERFEIT PRODUCTS:** If you ever need to replace your Spektrum receiver found in a Horizon Hobby product, always purchase from Horizon Hobby, LLC or a Horizon Hobby authorized dealer to ensure authentic high-quality Spektrum product. Horizon Hobby, LLC disclaims all support and warranty with regards, but not limited to, compatibility and performance of counterfeit products or products claiming compatibility with DSM or Spektrum technology.

Box Contents

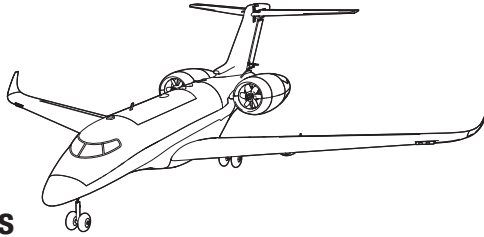
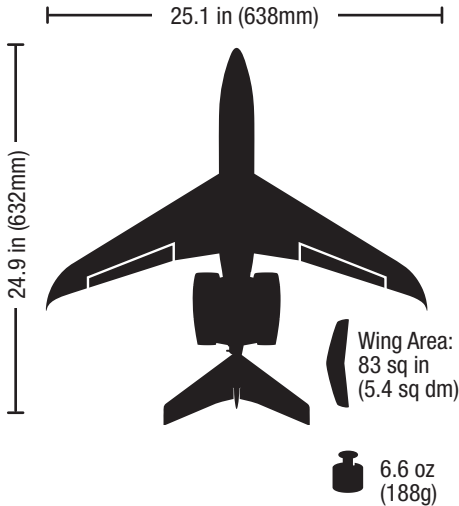

Table of Contents

| | | | |
|---|----|--|----|
| Transmitter Setup | 4 | Flying Tips and Repairs | 11 |
| Transmitter and Receiver Binding..... | 4 | Post Flight Checklist | 11 |
| ESC/Receiver Arming, Battery Installation and Center of Gravity..... | 5 | Power Components Service | 12 |
| SAFE® Select Technology | 6 | AS3X Troubleshooting Guide | 13 |
| Low Voltage Cutoff (LVC) | 6 | Troubleshooting Guide | 13 |
| Control Centering | 7 | Replacement Parts List | 14 |
| Control Horn Settings..... | 7 | Recommended Parts List | 14 |
| Dual Rates..... | 7 | Limited Warranty | 15 |
| Control Direction Test..... | 8 | Warranty and Service Contact Information | 16 |
| AS3X® Control Direction Test..... | 9 | FCC Information..... | 16 |
| Landing Gear Removal..... | 10 | IC Information..... | 17 |
| | | Compliance Information for the European Union...17 | |

Specifications



Preflight Checklist

| | |
|---|---|
| 1 | Remove and inspect contents. |
| 2 | Read the instruction manual thoroughly. |
| 3 | Charge the flight battery. |
| 4 | Program your transmitter. |
| 5 | Install the fully charged flight battery in the aircraft. |
| 6 | Check the center of gravity (CG). |
| 7 | Bind the aircraft to your transmitter. |

Components

Installed

| | |
|-----------------|---|
| Motor | 8,800Kv Brushless Outrunner (EFLUM0810) |
| Fan | (2) 30mm EDF Unit (EFLDF30) (EFLDF30R) |
| Receiver | Spektrum DSMX® 6-Channel Receiver Dual ESC (SPMAR6430T) |
| Servo | 2.3-Gram Linear Long Throw Offset Servos (SPMSA2030LO) |

Required to Complete

| | |
|------------------------|---|
| Transmitter | Spektrum™ DSM2®/DSMX® with dual-rates (DX4e and up) |
| Battery | 800mAh 3S 11.1 V 30C Li-Po 18AWG JST (EFLB8003SJ30) |
| Battery Charger | S150 AC/DC SMART Charger, 1x50W (SPMXC1070) |
| Battery Adapter | IC3 Battery JST device (SPMXCA310) |

| | |
|----|---|
| 8 | Make sure all linkages move freely. |
| 9 | Perform the control direction test. |
| 10 | Adjust the flight controls and transmitter as needed. |
| 11 | Perform a radio system range test. |
| 12 | Find a safe open area to fly. |
| 13 | Plan flight for flying field conditions. |

Transmitter Setup

IMPORTANT: After you set up your model, always rebind the transmitter and receiver to set the desired failsafe positions.

If your transmitter allows it, enable the throttle cut feature. Always engage throttle cut before approaching the aircraft.

Dual Rates

Low rate is recommended for the initial flights.

NOTICE: To ensure AS3X[®] technology functions properly, do not lower rate values below 50%.

NOTICE: If oscillation occurs at high speed, refer to the Troubleshooting Guide for more information.

| Computerized Transmitter Setup (DX6, DX6e, DX7, DX7S, DX8, DX8e, DX9, DX10t, DX18, DX20, iX12 and iX20) | |
|--|------------|
| Start all transmitter programming with a blank ACRO model (do a model reset), then name the model. | |
| Reversing | All Normal |
| Dual Rates | HIGH 100% |
| | LOW 70% |
| Expo | No Expo |
| Servo Travel | 100% |
| Timer | 5 minutes |
| Set Throttle cut to | -130% |

Expo

After your initial flights, you may adjust the expo value to better suit your flying style.

Transmitter and Receiver Binding

Binding is the process of programming the receiver to recognize the GUID (Globally Unique Identifier) code of a single specific transmitter. You need to 'bind' your chosen Spektrum™ DSM2/DSMX technology equipped aircraft transmitter to the receiver for proper operation.

Any full range Spektrum DSM2/DSMX transmitter can bind to the DSM2/DSMX receiver. Please visit www.bindnfly.com for a complete list of compatible transmitters.

Binding Procedure

1. Refer to your transmitter's unique instructions for binding to a receiver (location of transmitter's Bind control).
2. Make sure the flight battery is disconnected from the aircraft.
3. Power off your transmitter.
4. Place the aircraft on a level surface away from wind.
5. Connect the flight battery in the aircraft. The receiver LED will begin to flash rapidly (typically after 5 seconds).
6. Make sure the transmitter controls are neutral and the throttle and throttle trim are in low position.
7. Put your transmitter into bind mode. Refer to your transmitter's manual for binding button or switch instructions.
8. After 5 to 10 seconds, the receiver status LED will turn solid, indicating that the receiver is bound to the transmitter. If the LED does not turn solid, refer to the Troubleshooting Guide at the back of the manual.

For subsequent flights, power ON the transmitter for 5 seconds before connecting the flight battery.

ESC/Receiver Arming, Battery Installation and Center of Gravity

CAUTION: Always keep material or debris away from the intakes. When armed, the rotors will turn in response to throttle movement and could ingest in any loose objects.

Arming the ESC/receiver also occurs after binding as previously described, but subsequent connection of a flight battery requires the following steps.

1. Remove the battery hatch from the fuselage.
2. Install a flight battery in the center of the battery compartment. Ensure the battery is secured by the hook and loop strip. Re-install battery hatch on the fuselage.

Center of Gravity (CG)

The CG location is 88-92mm back from the leading edge of the wing at the root. Balance the airplane inverted on this recommended CG mark with all landing gear installed. Adjust as needed by sliding the battery forward or back.

3. Lower the throttle and throttle trim to the lowest settings on your transmitter. Power on your transmitter, then wait 5 seconds.
4. Place the aircraft upright and connect the battery to the ESC, noting proper polarity. **Keep the plane immobile and away from wind for 5 seconds to allow the AS3X system to initialize.**

A successful connection is indicated by:

- A series of tones
- A continuous LED

CAUTION: Always disconnect the Li-Po battery from the ESC when not flying to eliminate power supplied to the motor. The ESC does not have an arming switch and will respond to any transmitter input when a signal is present.

CAUTION: Always disconnect the Li-Po battery from the ESC when not flying to avoid over-discharging the battery. Batteries discharged to a voltage lower than the lowest approved voltage may become damaged, resulting in loss of performance and potential fire when batteries are charged.

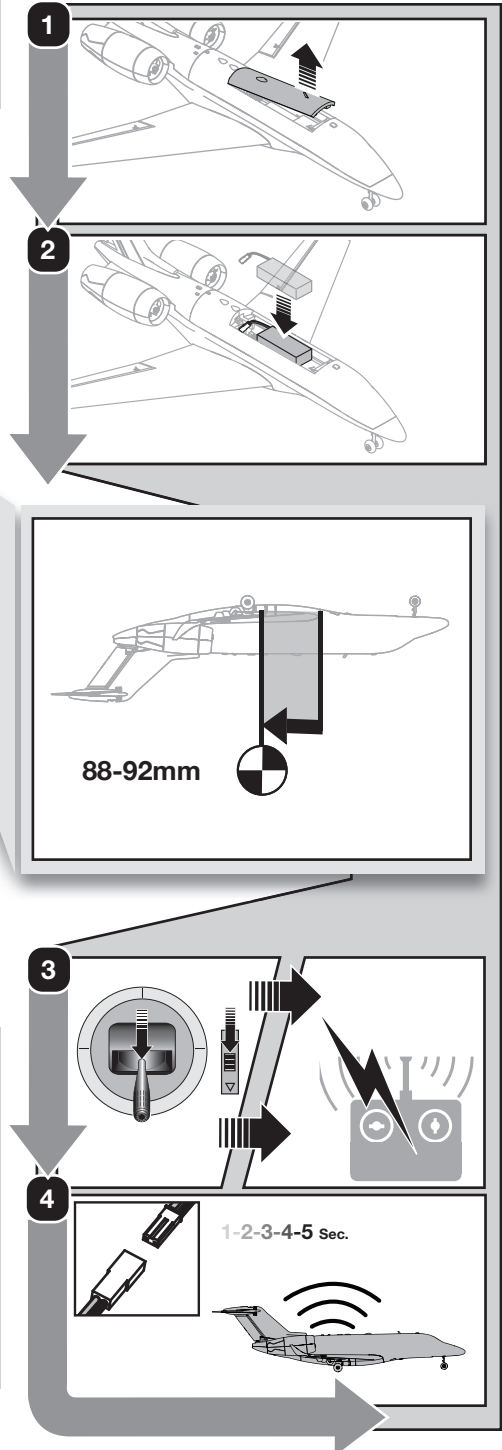

SAFE® Select Technology

When SAFE Select is activated, bank and pitch limitations keep you from over-controlling the aircraft. Additionally, by releasing the controls in the event you lose orientation, SAFE Select will keep the aircraft level.

To activate SAFE® Select, flip the Gear channel switch to position 0. Return the Gear switch to position 1 to turn OFF SAFE Select and fly with just the assistance of AS3X® technology.

If you become disoriented or the aircraft is in a confusing attitude, flip the Gear switch to position 0 and release the sticks. With the aileron, elevator and rudder sticks in the neutral position, SAFE Select will automatically keep the airplane in a straight and level attitude.

Disabling and Enabling SAFE Select

By default, the SAFE Select function of your UMX aircraft is enabled and assigned to the Gear channel switch (channel 5). If you do not wish to have access to SAFE Select while flying, you can choose to disable SAFE Select functionality. AS3X will still be active when SAFE Select is disabled.

IMPORTANT: Before attempting to disable or enable SAFE Select, ensure the aileron, elevator, rudder, throttle and gear channels are all on high rate with the travel set to 100%. Turn throttle hold OFF if it is programmed in the transmitter.



CAUTION: Keep all body parts clear of the rotor, intake and exhaust tube and keep the aircraft securely restrained in case of accidental throttle activation.

1. Power on the transmitter.
2. Power on the aircraft.
3. Hold both transmitter sticks to the inside bottom corners and toggle the Gear switch 5 times (1 toggle = full up and down). The control surfaces of the aircraft will move, indicating SAFE Select has been enabled or disabled.

Repeat the process again to re-enable or disable SAFE Select.

DX4e, DX5e, and DXe Transmitters

The Gear switch is the FMODE switch on these transmitters, and the switch needs to be toggled between position 0 and 2 when disabling/enabling SAFE-Select.

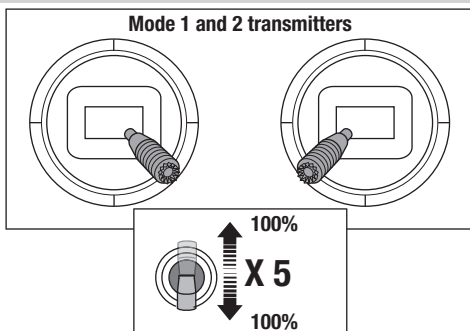

Low Voltage Cutoff (LVC)

When a Li-Po battery is discharged below 3V per cell, it will not hold a charge. The aircraft's ESC protects the flight battery from over-discharge using Low Voltage Cutoff (LVC). Before the battery charge decreases too much, LVC removes power supplied to the motor. Power to the motor quickly decreases and increases, showing that some battery power is reserved for flight control and safe landing.

When the motor power pulses, land the aircraft immediately and recharge the flight battery.

Disconnect and remove the Li-Po battery from the aircraft after use to prevent trickle discharge. During storage, make sure the battery charge does not fall below 3V per cell.

TIP: Due to the quiet nature of the aircraft, you may not hear the pulsing of the motor.

For your first flights, set your transmitter timer or a stopwatch to 5 minutes. Adjust your timer for longer or shorter flights once you have flown the aircraft. Flights of 7 minutes or more are achievable if using proper throttle management.

NOTICE: Repeated flying to LVC will damage the battery.

Control Centering

Before the first flights, or in the event of an accident, make sure the flight control surfaces are centered. Adjust the linkages mechanically if the control surfaces are not centered. Use of the transmitter sub-trims may not correctly center the aircraft control surfaces due to the mechanical limits of linear servos.

1. Ensure SAFE Select is OFF.
2. Make sure the control surfaces are neutral when the transmitter controls and trims are centered. The transmitter sub-trim must always be set to zero.
3. When needed, use a pair of pliers to carefully bend the metal linkage (see illustration).
4. Make the U-shape narrower to make the connector shorter. Make the U-shape wider to make the linkage longer.

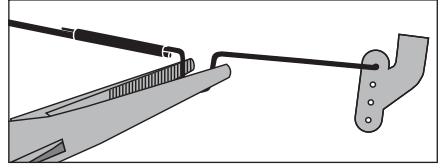

Centering Controls After First Flights
For best performance with AS3X, it is important that excessive trim is not used. Do not trim the aircraft while SAFE Select is active. Always trim the aircraft in AS3X mode. If the model requires excessive transmitter trim (4 or more clicks of trim per channel), return the transmitter trim to zero and adjust the linkages mechanically so that the control surfaces are in the flight trimmed position.

Control Horn Settings

The table to the right shows the factory settings for the control horns. Fly the aircraft at factory settings.



CAUTION: When these are incorrectly connected for the pilot's skill level, unexpected aircraft response to controls can result. This can cause damage to the aircraft and personal injury.

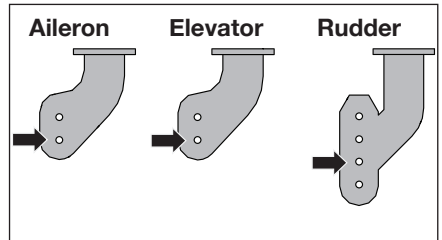

Dual Rates

To obtain the best flight performance, we recommend using a DSM2/DSMX radio capable of adjustable Dual Rates. The suggested settings shown here are the recommended starting settings. Adjust according to the individual preferences after the initial flight.

NOTICE: Do not set your transmitter travel adjust over 100%. If the TRAVEL ADJUST is set over 100%, it will not result in more control movement, it will overdrive the servo and cause damage.





| | Dual Rate | |
|----------|-----------|-----|
| | High | Low |
| Aileron | 100% | 70% |
| Elevator | 100% | 70% |
| Rudder | 100% | 70% |

Tip: For the first flight, fly the model in low rate.

It is normal for linear servos to make significant noise. The noise is not an indication of a faulty servo.

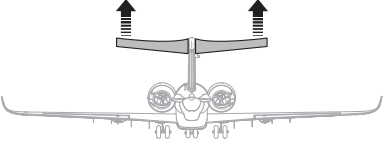

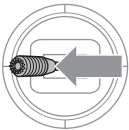
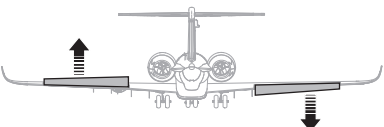
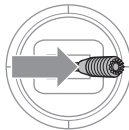
Control Direction Test

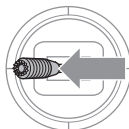
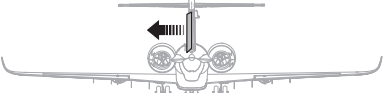
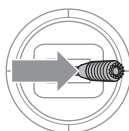
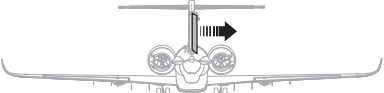
Switch on the transmitter and connect the battery. Use the transmitter to operate the aileron, elevator and rudder controls. View the aircraft from the rear when checking the control directions.

| | | Transmitter command | Control Surface Response |
|---|----------|---|--|
| Elevators 1. Pull the elevator stick back. The elevators should move up, which will cause the aircraft to pitch up. 2. Push the elevator stick forward. The elevators should move down, which will cause the aircraft to pitch down. | Elevator |  |  |
| | |  |  |
| Ailerons 1. Move the aileron stick to the left. The Left aileron should move up and the Right aileron down, which will cause the aircraft to bank left. 2. Move the aileron stick to the right. The right aileron should move up and the left aileron down, which will cause the aircraft to bank right. | Aileron |  |  |
| | |  |  |
| Rudder 1. Move the rudder stick to the left. The rudders should move to the left, which will cause the aircraft to yaw left. 2. Move the rudder stick to the right. The rudders should move to the right, which will cause the aircraft to yaw right. | Rudder |  |  |
| | |  |  |

AS3X® Control Direction Test

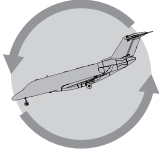
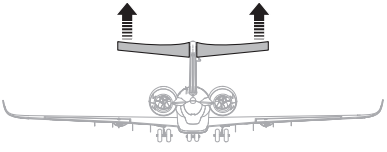
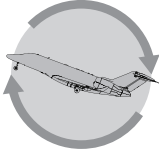
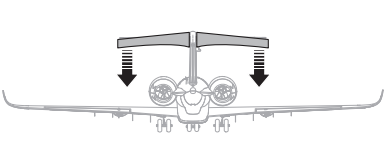
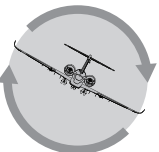
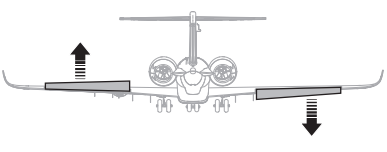
This test is meant to check that the AS3X® system is functioning properly.

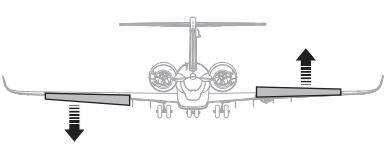
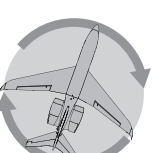
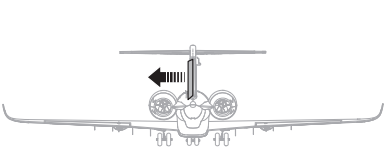
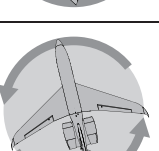
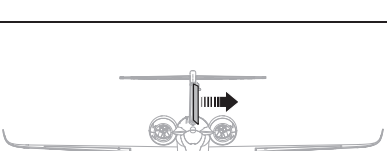
| | | Aircraft movement | AS3X Reaction |
|--|----------|---|--|
| <ol style="list-style-type: none"> Advance the throttle above 25% to activate the AS3X system. Fully lower the throttle. Move the entire aircraft as shown and ensure the control surfaces move in the direction indicated in the graphic. If the control surfaces do not respond as shown, do not fly the aircraft. Refer to the receiver manual for more information. <p>Once the AS3X system is active, control surfaces may move rapidly. This is normal. AS3X is active until the battery is disconnected.</p> | Elevator |  |  |
| | |  |  |
| | Aileron |  |  |
| | |  |  |
| | Rudder |  |  |
| | |  |  |

Landing Gear Removal

Main Gear

1. Lift the end of the landing gear wire above the stop.
2. Gently pull the landing gear away from the clip.

When needed, assemble in reverse order.

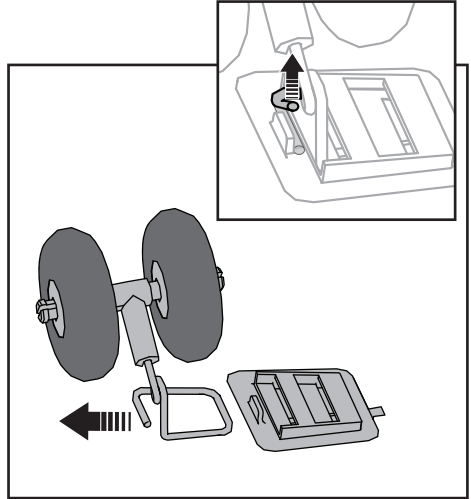

Nose Gear

1. Gently pull the nose gear away from the plastic nose gear mount located on the bottom of the fuselage.

When needed, assemble in reverse order.

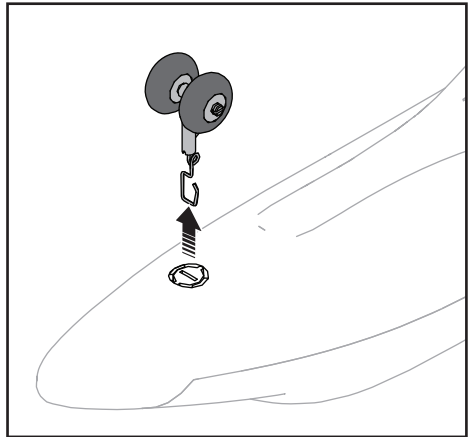

Flying Tips and Repairs

Range Check your Radio System

After final assembly, range check the radio system with the aircraft. Refer to your specific transmitter instruction manual for range test information.

Flying

We recommend flying your aircraft outside in no greater than moderate winds. Always avoid flying near houses, trees, wires and buildings. You should also be careful to avoid flying in areas where there are many people, such as busy parks, schoolyards or soccer fields. Consult local laws and ordinances before choosing a location to fly your aircraft.

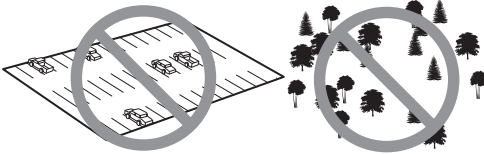

Hand Launching

To hand launch the aircraft, hold the fuselage behind the wings. Advance to the throttle to 3/4 throttle and give the aircraft a firm throw, slightly up (5–10 degrees above the horizon), and directly into the wind. After the model gains altitude and speed, decrease the throttle as you desire.

TIP: The electric ducted fan (EDF) acts like a jet aircraft, so control is generated by airspeed rather than air from a propeller moving over the control surfaces.

Takeoff

Taxi the aircraft in position for takeoff (facing into the wind if flying outdoors). Gradually increase the throttle to full power. Hold a small amount of up elevator and steer with the rudder. When the aircraft lifts off, climb gently and adjust the trim for level flight. Do not trim the aircraft while SAFE Select is active. Always trim the aircraft in AS3X mode. Once the trim is adjusted, begin exploring the flight envelope of the aircraft.

Post Flight Checklist

| | |
|---|--|
| 1 | Disconnect the flight battery from the ESC. |
| 2 | Power OFF the transmitter. |
| 3 | Remove the flight battery from the aircraft. |
| 4 | Recharge the flight battery. |
| 5 | Repair or replace all damaged parts. |

Landing

Always land into the wind. Fly the landing pattern with a slightly nose high attitude. Use throttle management to control the descent rate of the aircraft.

During flare, keep the wings level and the aircraft pointed into the wind. Slowly lower the throttle while easing back on the elevator to bring the aircraft gently down on the main wheels or to smoothly belly land.

NOTICE: Always fully lower the throttle at touch down when landing the aircraft to prevent intake of foreign objects, which can damage the ducted fans and motors.

Failure to lower the throttle stick and trim to the lowest possible positions during a crash could result in damage to the ESC in the receiver unit.

Over-Current Protection (OCP)

The aircraft is equipped with over-current protection. OCP protects the ESC from overheating and stops the motor when the transmitter throttle is set too high and the rotor cannot turn. OCP will only activate when the throttle is positioned just above 1/2 throttle. After the ESC stops the motor, fully lower the throttle to re-arm the ESC.

Repairs

Crash damage is not covered under warranty.

Repair this aircraft using foam-compatible CA glue or clear tape. Only use foam-compatible CA glue as other types of glue can damage the foam. When parts are not repairable, see the Replacement Parts List for ordering by item number.

NOTICE: Use of foam-compatible CA accelerant on your aircraft can damage paint. DO NOT handle the aircraft until accelerant fully dries.

| | |
|---|--|
| 6 | Store the flight battery apart from the aircraft and monitor the battery charge. |
| 7 | Make note of the flight conditions and flight plan results, planning for future flights. |

Power Components Service

Disassembly



CAUTION: DO NOT handle the rotor or motor while the flight battery is connected. Personal injury could result.

1. Carefully cut the tape and/or decals on the side of the fuselage to remove the top of the fuselage to access the motor connection to the ESC.
2. Carefully cut the tape on the bottom of the fuselage to remove the bottom compartment cover from the fuselage to access the motor wires.
3. Remove (2) rotor screws (A) from the rotor with a 1.5 m screw driver or wrench.
4. Remove the rotor (B) from the motor shaft.
5. Disconnect the motor wire connector from the ESC/receiver connector.
6. Remove the (3) motor screws (D) from the motor mount through the back of the nacelle.
7. Remove the motor (C) from motor mount and through the front of the nacelle.

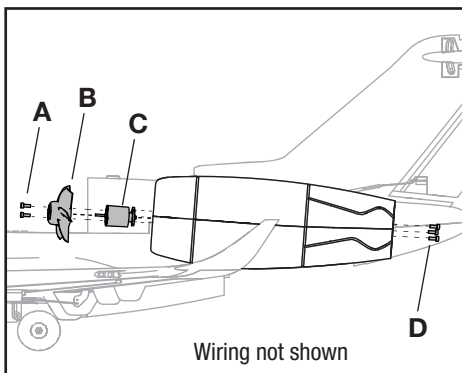
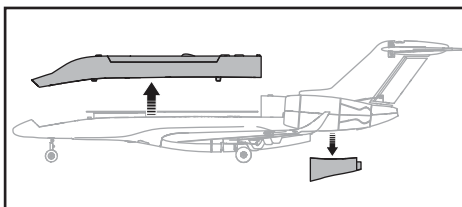

Assembly

Assemble in reverse order, connecting the top half of the fuselage and the bottom compartment cover seams with clear tape.

NOTICE: Always install the motor mount so that the rotor faces the front of the fuselage.

AS3X Troubleshooting Guide

| Problem | Possible Cause | Solution |
|---|---|---|
| Control surfaces not at neutral position when transmitter controls are at neutral | Control surfaces may not have been mechanically centered from factory | Center control surfaces mechanically by adjusting the U-bends on control linkages |
| | Aircraft was not kept immobile for 5 seconds after battery was plugged in | Keep the aircraft immobile for 5 seconds after plugging in the battery |
| Model flies inconsistently from flight to flight | Aircraft was not kept immobile for 5 seconds after battery was plugged in | Keep the aircraft immobile for 5 seconds after plugging in the battery |
| | Trims are moved too far from neutral position | Neutralize trims and mechanically adjust linkages to center control surfaces |
| Controls oscillate in flight, (model rapidly jumps or moves) | Rotor is unbalanced, causing excessive vibration | Remove rotor and motor. Check motor shaft for straightness and replace rotor if damaged |

Troubleshooting Guide

| Problem | Possible Cause | Solution |
|--|---|--|
| Aircraft will not respond to throttle but responds to other controls | Throttle stick and/or throttle trim too high | Reset controls with throttle stick and throttle trim at lowest setting |
| | Throttle channel is reversed | Reverse throttle channel on transmitter |
| | Motor disconnected from receiver | Open fuselage and make sure motor is connected to the receiver |
| Extra motor noise or extra vibration | Damaged rotor or motor | Replace damaged parts |
| | Rotor out of balance | Balance or replace the rotor |
| Reduced flight time or aircraft underpowered | Flight battery charge is low | Completely recharge flight battery |
| | Flight battery damaged | Replace flight battery and follow flight battery instructions |
| | Flight conditions may be too cold | Make sure battery is warm before use |
| | Battery capacity too low for flight conditions | Replace battery or use a larger capacity battery |
| LED on receiver flashes and aircraft will not bind to transmitter (during binding) | Transmitter too near aircraft during binding process | Power off transmitter, move transmitter a larger distance from aircraft, disconnect and reconnect flight battery to aircraft and follow binding instructions |
| | Bind switch or button not held long enough during bind process | Power off transmitter and repeat bind process. Hold transmitter bind button or switch until receiver is bound |
| LED on receiver flashes rapidly and aircraft will not respond to transmitter (after binding) | Less than a 5-second wait between first powering on transmitter and connecting flight battery to aircraft | Leaving transmitter on, disconnect and reconnect flight battery to aircraft |
| | Aircraft bound to different model memory (ModelMatch™ radios only) | Select correct model memory on transmitter and disconnect and reconnect flight battery to aircraft |
| | Flight battery/transmitter battery charge is too low | Replace/recharge batteries |
| Control surface does not move | Control surface, control horn, linkage or servo damage | Replace or repair damaged parts and adjust controls |
| | Wire damaged or connections loose | Do a check of wires and connections, connect or replace as needed |
| | Flight battery charge is low | Fully recharge flight battery |
| | Control linkage does not move freely | Make sure control linkage moves freely |
| Controls reversed | Transmitter settings reversed | Adjust controls on transmitter appropriately |
| Motor loses power | Damage to motor or power components | Do a check of motor and power components for damage (replace as needed) |

Troubleshooting Guide (Continued)

| Problem | Possible Cause | Solution |
|--|---|---|
| Motor power quickly decreases and increases then motor loses power | Battery power is down to the point of receiver/ESC Low Voltage Cutoff (LVC) | Recharge flight battery or replace battery that is no longer performing |
| Motor/ESC is not armed after landing | Over Current Protection (OCP) stops the motor when the transmitter throttle is set high and the rotor cannot turn | Fully lower throttle and throttle trim to arm ESC |
| Servo locks or freezes at full travel | Travel adjust value is set above 100% overdriving the servo | Set Travel adjust to 100% or less and/or set sub-trims to zero and adjust linkages mechanically |

Replacement Parts List

| Part # | Description |
|-------------|---------------------------------|
| EFLDF30 | Ducted Fan Unit:6-Blade, 30mm |
| EFLDF30R | 6-Blade Rotor, 30mm |
| EFLU6352 | Painted Wing: Longitude |
| EFLU6353 | Horizontal Stabilizer: Longitud |
| EFLU6354 | Vertical Fin: Longitude |
| EFLU6355 | Battery Hatch: Longitude |
| EFLU6356 | Landing Gear Set: Longitude |
| EFLU6357 | Light Set: Longitude |
| EFLU6358 | Decal Sheet: Longitude |
| EFLU6359 | Pushrod Set: Longitude |
| EFLU6360 | Nacelle Set: Longitude |
| EFLUM0810 | 8,800Kv Brushless Outrunner |
| SPMAR6430T | DSMX 6-Channel Receiver Dual ES |
| SPMSA2030LO | 2.3 g Liner Long Offset Servo |

Recommended Parts List

| Part # | Description |
|--------------|-----------------------------------|
| EFLB8003SJ30 | 800mAh3S11.1V30C LiPo, 18AWG JST |
| SPMXC1070 | S150 AC/DC Smart Charger, 1x50W |
| SPMXCA310 | Adapter: IC3 Battery / JST Device |

Limited Warranty

What this Warranty Covers

Horizon Hobby, LLC, (Horizon) warrants to the original purchaser that the product purchased (the "Product") will be free from defects in materials and workmanship at the date of purchase.

What is Not Covered

This warranty is not transferable and does not cover (i) cosmetic damage, (ii) damage due to acts of God, accident, misuse, abuse, negligence, commercial use, or due to improper use, installation, operation or maintenance, (iii) modification of or to any part of the Product, (iv) attempted service by anyone other than a Horizon Hobby authorized service center, (v) Product not purchased from an authorized Horizon dealer, (vi) Product not compliant with applicable technical regulations, or (vii) use that violates any applicable laws, rules, or regulations.

OTHER THAN THE EXPRESS WARRANTY ABOVE, HORIZON MAKES NO OTHER WARRANTY OR REPRESENTATION, AND HEREBY DISCLAIMS ANY AND ALL IMPLIED WARRANTIES, INCLUDING, WITHOUT LIMITATION, THE IMPLIED WARRANTIES OF NON-INFRINGEMENT, MERCHANTABILITY AND FITNESS FOR A PARTICULAR PURPOSE. THE PURCHASER ACKNOWLEDGES THAT THEY ALONE HAVE DETERMINED THAT THE PRODUCT WILL SUITABLY MEET THE REQUIREMENTS OF THE PURCHASER'S INTENDED USE.

Purchaser's Remedy

Horizon's sole obligation and purchaser's sole and exclusive remedy shall be that Horizon will, at its option, either (i) service, or (ii) replace, any Product determined by Horizon to be defective. Horizon reserves the right to inspect any and all Product(s) involved in a warranty claim. Service or replacement decisions are at the sole discretion of Horizon. Proof of purchase is required for all warranty claims. SERVICE OR REPLACEMENT AS PROVIDED UNDER THIS WARRANTY IS THE PURCHASER'S SOLE AND EXCLUSIVE REMEDY.

Limitation of Liability

HORIZON SHALL NOT BE LIABLE FOR SPECIAL, INDIRECT, INCIDENTAL OR CONSEQUENTIAL DAMAGES, LOSS OF PROFITS OR PRODUCTION OR COMMERCIAL LOSS IN ANY WAY, REGARDLESS OF WHETHER SUCH CLAIM IS BASED IN CONTRACT, WARRANTY, TORT, NEGLIGENCE, STRICT LIABILITY OR ANY OTHER THEORY OF LIABILITY, EVEN IF HORIZON HAS BEEN ADVISED OF THE POSSIBILITY OF SUCH DAMAGES.

Further, in no event shall the liability of Horizon exceed the individual price of the Product on which liability is asserted. As Horizon has no control over use, setup, final assembly, modification or misuse, no liability shall be assumed nor accepted for any resulting damage or injury. By the act of use, setup or assembly, the user accepts all resulting liability. If you as the purchaser or user are not prepared to accept the liability associated with the use of the Product, purchaser is advised to return the Product immediately in new and unused condition to the place of purchase.

Law

These terms are governed by Illinois law (without regard to conflict of law principals). This warranty gives you specific legal rights, and you may also have other rights which vary from state to state. Horizon reserves the right to change or modify this warranty at any time without notice.

WARRANTY SERVICES

Questions, Assistance, and Services

Your local hobby store and/or place of purchase cannot provide warranty support or service. Once assembly, setup or use of the Product has been started, you must contact your local distributor or Horizon directly. This will enable Horizon to better answer your questions and service you in the event that you may need any assistance. For questions or assistance,

please visit our website at www.horizonhobby.com, submit a Product Support Inquiry, or call the toll free telephone number referenced in the Warranty and Service Contact Information section to speak with a Product Support representative.

Inspection or Services

If this Product needs to be inspected or serviced and is compliant in the country you live and use the Product in, please use the Horizon Online Service Request submission process found on our website or call Horizon to obtain a Return Merchandise Authorization (RMA) number. Pack the Product securely using a shipping carton. Please note that original boxes may be included, but are not designed to withstand the rigors of shipping without additional protection. Ship via a carrier that provides tracking and insurance for lost or damaged parcels, as Horizon is not responsible for merchandise until it arrives and is accepted at our facility. An Online Service Request is available at http://www.horizonhobby.com/content/service-center_renderer-service-center. If you do not have internet access, please contact Horizon Product Support to obtain a RMA number along with instructions for submitting your product for service. When calling Horizon, you will be asked to provide your complete name, street address, email address and phone number where you can be reached during business hours. When sending product into Horizon, please include your RMA number, a list of the included items, and a brief summary of the problem. A copy of your original sales receipt must be included for warranty consideration. Be sure your name, address, and RMA number are clearly written on the outside of the shipping carton.

NOTICE: Do not ship LiPo batteries to Horizon. If you have any issue with a LiPo battery, please contact the appropriate Horizon Product Support office.

Warranty Requirements

For Warranty consideration, you must include your original sales receipt verifying the proof-of-purchase date. Provided warranty conditions have been met, your Product will be serviced or replaced free of charge. Service or replacement decisions are at the sole discretion of Horizon.

Non-Warranty Service

Should your service not be covered by warranty, service will be completed and payment will be required without notification or estimate of the expense unless the expense exceeds 50% of the retail purchase cost. By submitting the item for service you are agreeing to payment of the service without notification. Service estimates are available upon request. You must include this request with your item submitted for service. Non-warranty service estimates will be billed a minimum of ½ hour of labor. In addition you will be billed for return freight. Horizon accepts money orders and cashier's checks, as well as Visa, MasterCard, American Express, and Discover cards. By submitting any item to Horizon for service, you are agreeing to Horizon's Terms and Conditions found on our website http://www.horizonhobby.com/content/service-center_renderer-service-center.

ATTENTION: Horizon service is limited to Product compliant in the country of use and ownership. If received, a non-compliant Product will not be serviced. Further, the sender will be responsible for arranging return shipment of the un-serviced Product, through a carrier of the sender's choice and at the sender's expense. Horizon will hold non-compliant Product for a period of 60 days from notification, after which it will be discarded.

Warranty and Service Contact Information

| Country of Purchase | Horizon Hobby | Contact Information | Address |
|--------------------------|---|---|---|
| United States of America | Horizon Service Center (Repairs and Repair Requests) | servicecenter.horizonhobby.com/ RequestForm/ | 2904 Research Rd Champaign, IL 61822 |
| | Horizon Product Support (Product Technical Assistance) | productsupport@horizonhobby.com 877-504-0233 | |
| | Sales | websales@horizonhobby.com 800-338-4639 | |
| European Union | Horizon Technischer Service | service@horizonhobby.eu | Hanskampring 9 D 22885 Barsbüttel, Germany |
| | Sales: Horizon Hobby GmbH | +49 (0) 4121 2655 100 | |

FCC Information

Contains FCC ID: BRWWAC01T

This equipment has been tested and found to comply with the limits for a Class B digital device, pursuant to part 15 of the FCC Rules. These limits are designed to provide reasonable protection against harmful interference in a residential installation. This equipment generates, uses and can radiate radio frequency energy and, if not installed and used in accordance with the instructions, may cause harmful interference to radio communications.

NOTICE: Modifications to this product will void the user's authority to operate this equipment.

This product contains a radio transmitter with wireless technology which has been tested and found to be compliant with the applicable regulations governing a radio transmitter in the 2.400GHz to 2.4835GHz frequency range.

Supplier's Declaration of Conformity

UMX Citation Longitude BNF Basic SAFE (EFLU6350)

FC This device complies with part 15 of the FCC Rules. Operation is subject to the following two conditions: (1) This device may not cause harmful interference, and (2) this device must accept any interference received, including interference that may cause undesired operation.



CAUTION: Changes or modifications not expressly approved by the party responsible for compliance could void the user's authority to operate the equipment.

NOTE: This equipment has been tested and found to comply with the limits for a Class B digital device, pursuant to part 15 of the FCC Rules. These limits are designed to provide reasonable protection against harmful interference in a residential installation. This equipment generates, uses and can radiate radio frequency energy and, if not installed and used in accordance with the instructions, may cause harmful interference to radio communications. However, there is no guarantee that interference will not occur in a particular installation. If this equipment does cause harmful interference to radio or television reception, which can be determined by turning the equipment off and on, the user is encouraged to try to correct the interference by one or more of the following measures:

- Reorient or relocate the receiving antenna.
- Increase the separation between the equipment and receiver.
- Connect the equipment into an outlet on a circuit different from that to which the receiver is connected.
- Consult the dealer or an experienced radio/TV technician for help.

Horizon Hobby, LLC
4105 Fieldstone Rd.,
Champaign, IL 61822
Email: compliance@horizonhobby.com
Web: HorizonHobby.com

IC Information

Contains IC: 6157A-WAC01T

CAN ICES-3 (B)/NMB-3(B) This device complies with Industry Canada licence-exempt RSS standard(s). Operation is subject to the following two conditions:

(1) this device may not cause interference, and (2) this device must accept any interference, including interference that may cause undesired operation of the device.

Compliance Information for the European Union



EU Compliance Statement:

UMX Citation Longitude BNF Basic SAFE (EFLU6350)

Horizon Hobby, LLC hereby declares that this product is in compliance with the essential requirements and other relevant provisions of the RED and EMC Directives.

A copy of the EU Declaration of Conformity is available online at:
<http://www.horizonhobby.com/content/support-render-compliance>.

Instructions for disposal of WEEE by users in the European Union

This product must not be disposed of with other waste. Instead, it is the user's responsibility to dispose of their waste equipment by handing it over to a designated collections point for the recycling of waste electrical and electronic equipment. The separate collection and recycling of your waste equipment at the time of disposal will help to conserve natural resources and ensure that it is recycled in a manner that protects human health and the environment. For more information about where you can drop off your waste equipment for recycling, please contact your local city office, your household waste disposal service or where you purchased the product.



E328



© 2020 Horizon Hobby, LLC.

E-flite, UMX, SAFE, the SAFE logo, AS3X, DSM, DSM2, DSMX, Bind-N-Fly, BNF, the BNF logo, ModelMatch, Celectra, Delta-V, and the Horizon Hobby logo are trademarks or registered trademarks of Horizon Hobby, LLC.

The Spektrum trademark is used with permission of Bachmann Industries, Inc.

Cessna Citation Longitude are trademarks of Textron Innovations Inc. and are used under license to Horizon Hobby LLC.

All other trademarks, service marks and logos are property of their respective owners.

US 9,056,667. US 9,753,457. US 10,078,329. US 7,898,130. D578,146. US 9,930,567. US 10,419,970.

www.horizonhobby.com