



# DX8e

8-Channel 2.4GHz DSMX® Aircraft System



Instruction Manual  
Bedienungsanleitung  
Manuel d'utilisation  
Manuale di Istruzioni



**NOTICE**

All instructions, warranties and other collateral documents are subject to change at the sole discretion of Horizon Hobby, LLC. For up-to-date product literature, visit [horizonhobby.com](http://horizonhobby.com) and click on the support tab for this product.

**Meaning of Special Language**

The following terms are used throughout the product literature to indicate various levels of potential harm when operating this product:

**WARNING:** Procedures, which if not properly followed, create the probability of property damage, collateral damage and serious injury OR create a high probability of superficial injury.

**CAUTION:** Procedures, which if not properly followed, create the probability of physical property damage AND a possibility of serious injury.

**NOTICE:** Procedures, which if not properly followed, create a possibility of physical property damage AND little or no possibility of injury.



**WARNING:** Read the ENTIRE instruction manual to become familiar with the features of the product before operating. Failure to operate the product correctly can result in damage to the product, personal property and cause serious injury.

This is a sophisticated hobby product. It must be operated with caution and common sense and requires some basic mechanical ability. Failure to operate this Product in a safe and responsible manner could result in injury or damage to the product or other property. This product is not intended for use by children without direct adult supervision. Do not attempt disassembly, use with incompatible components or augment product in any way without the approval of Horizon Hobby, LLC. This manual contains instructions for safety, operation and maintenance. It is essential to read and follow all the instructions and warnings in the manual, prior to assembly, setup or use, in order to operate correctly and avoid damage or serious injury.

**WARNING AGAINST COUNTERFEIT PRODUCTS**

Always purchase from a Horizon Hobby, LLC authorized dealer to ensure authentic high-quality Spektrum product. Horizon Hobby, LLC disclaims all support and warranty with regards, but not limited to, compatibility and performance of counterfeit products or products claiming compatibility with DSM or Spektrum technology.

**NOTICE:** This product is only intended for use with unmanned, hobby-grade, remote-controlled vehicles and aircraft. Horizon Hobby disclaims all liability outside of the intended purpose and will not provide warranty service related thereto.

**Age Recommendation: Not for Children under 14 years. This is not a toy.**

**WARRANTY REGISTRATION**

Visit [spektrumrc.com](http://spektrumrc.com) today to register your product.

**NOTICE:** While DSMX technology allows you to use more than 40 transmitters simultaneously, when using DSM2 receivers, DSMX receivers in DSM2 mode or transmitters in DSM2 mode, do not use more than 40 transmitters simultaneously.

**General Notes**

- Models are hazardous when operated and maintained incorrectly.
- Always install and operate a radio control system correctly.
- Always pilot a model so the model is kept under control in all conditions.
- Please seek help from an experienced pilot or your local hobby store.
- Contact local or regional modeling organizations for guidance and instructions about flying in your area.
- When working with a model, always power on the transmitter first and power off the transmitter last.
- After a model is bound to a transmitter and the model is set up in the transmitter, always bind the model to the transmitter again to establish failsafe settings.

**Pilot Safety**

- Always make sure all batteries are fully charged before flying.
- Time flights so you can fly safely within the time allotted by your battery.
- Perform a range check of the transmitter and the model before flying the model.
- Make sure all control surfaces correctly respond to transmitter controls before flying.
- Do NOT fly a model near spectators, parking areas or any other area that could result in injury to people or damage to property.
- Do NOT fly during adverse weather conditions. Poor visibility, wind, moisture and ice can cause pilot disorientation and/or loss of control of a model.
- When a flying model does not respond correctly to controls, land the model and correct the cause of the problem.

## BATTERY AND CHARGING PRECAUTIONS AND WARNINGS

Failure to exercise caution while using this product and comply with the following warnings could result in product malfunction, electrical issues, excessive heat, FIRE, and ultimately injury and property damage.

- **NEVER LEAVE THE BATTERY AND CHARGER UNATTENDED DURING USE**
- **NEVER CHARGE BATTERIES OVERNIGHT**
- Read all safety precautions and literature prior to use of this product
- **Never** allow minors to charge battery packs
- **Never** drop charger or batteries
- **Never** attempt to charge damaged batteries
- **Never** attempt to charge a battery pack containing different types of batteries
- **Never** charge a battery if the cable has been pinched or shorted
- **Never** allow batteries or battery packs to come into contact with moisture at any time
- **Never** charge batteries in extremely hot or cold places (recommended between 50–80° F or 10–27° C) or place in direct sunlight
- **Always** disconnect the battery after charging, and let the charger cool between charges
- **Always** inspect a new battery before charging
- **Always** terminate all processes and contact Horizon Hobby if the product malfunctions
- **Always** keep batteries and charger away from any material that could be affected by heat (such as ceramic and tile), as they can get hot
- **Always** end the charging process if the charger or battery becomes hot to the touch or starts to change form (swell) during the charge process



**CAUTION:** Risk of explosion if battery is replaced by an incorrect type. Dispose of used batteries according to state and local laws.



### BEFORE USING YOUR TRANSMITTER

Before going any further, visit the Spektrum Community website at [spektrumrc.com](http://spektrumrc.com) to register your transmitter and download the latest Spektrum AirWare™ firmware updates. A registration reminder screen occasionally appears until you register your transmitter. When you register your transmitter, the reminder screen does not appear again.

## BOX CONTENTS

- DX8e Transmitter (SPMR8100)
- 4 – AA Alkaline cells with holder
- Manual

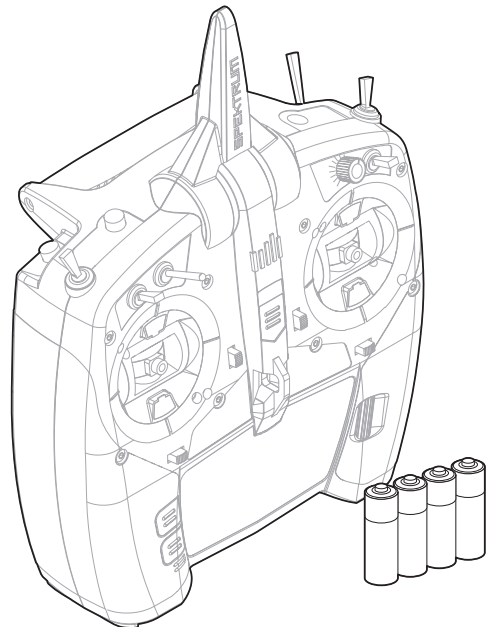

### Support Videos:

For helpful videos on programming the DX8e and other Spektrum AirWare™ equipped transmitters, go to [www.spektrumrc.com/](http://www.spektrumrc.com/)



# TABLE OF CONTENTS

<b>Battery and Charging Precautions and Warnings</b> .....	<b>3</b>	Reverse .....	29
<b>Box Contents</b> .....	<b>3</b>	Speed .....	30
<b>Installing the Transmitter Batteries</b> .....	<b>5</b>	Balance .....	30
<b>Installing Optional Lithium Ion Battery Pack</b> .....	<b>5</b>	AS3X Gain Live View (ACRO and SAIL Types Only) .....	30
<b>Charging the Lithium Ion Battery Pack</b> .....	<b>5</b>	D/R & Exponential .....	31
<b>Transmitter Functions</b> .....	<b>6-7</b>	Differential (ACRO and SAIL Types Only) .....	31
<b>Main Screen</b> .....	<b>8</b>	Throttle Cut (ACRO and HELI Types Only) .....	31
<b>Navigation</b> .....	<b>8</b>	Throttle Curve (ACRO and HELI Types Only) .....	31
Auto Switch Select .....	8	Mixing .....	32
<b>SD Card</b> .....	<b>9</b>	Assigning a Mix to a Switch .....	32
Installing the SD Card .....	9	Back Mixing .....	33
Registering the Transmitter with Spektrum .....	9	Range Test .....	33
Update Spektrum AirWare™ Software .....	10	Timer .....	33
<b>Binding</b> .....	<b>11</b>	Telemetry .....	34
<b>Receiver Power System Requirements</b> .....	<b>12</b>	System Setup .....	34
Recommended Power System Test Guidelines .....	12	Monitor .....	34
European Union Receiver Requirements .....	12	<b>ACRO (AIRPLANE)</b> .....	<b>35</b>
QuickConnect™ Technology with Brownout Detection .....	12	Aircraft Type .....	35
How QuickConnect Technology with Brownout Detection Works .....	12	Recommended Servo Connections .....	35
<b>Programming Failsafe Positions</b> .....	<b>13</b>	Icon .....	35
SmartSafe™ Failsafe .....	13	Elevon Servo Control .....	36
Hold Last Command .....	13	Flap System .....	36
Preset Failsafe .....	13	ACRO Mixing .....	36
<b>Model Type Programming Guide</b> .....	<b>14</b>	<b>HELI (HELICOPTER)</b> .....	<b>37</b>
<b>SYSTEM SETUP</b> .....	<b>15</b>	Swash Type .....	37
Model Select .....	15	Collective Type .....	37
Model Type .....	15	Pitch Curve .....	37
Model Name .....	16	Swashplate .....	38
F-Mode Setup .....	16	Gyro .....	38
Flight Mode Setup .....	17	Tail Curve .....	38
Channel Assignment .....	17	Mixing .....	38
Channel Input Configuration .....	17	<b>SAIL (SAILPLANE)</b> .....	<b>39</b>
Trim Setup .....	18	Sailplane Type .....	39
Model Utilities .....	18	Camber Preset .....	39
Warnings .....	19	Camber System .....	39
<b>Telemetry</b> .....	<b>20</b>	SAIL Mixing .....	40
Preflight Setup .....	21	V-Tail Differential .....	40
Frame Rate .....	21	<b>MULTI (MULTIROTOR)</b> .....	<b>41</b>
Bind .....	21	Multirotor Model Type .....	41
Digital Switch Setup .....	23	F-Mode Setup .....	41
<b>System Settings</b> .....	<b>24</b>	Trim Setup .....	41
User Name .....	24	D/R & Exponential .....	41
Contrast .....	24	Motor Cut .....	41
Backlight .....	24	Motor Curve .....	41
Mode .....	24	<b>PHYSICAL TRANSMITTER ADJUSTMENTS</b> .....	<b>43</b>
Battery Alarm .....	24	Ratcheted Throttle –Smooth Throttle Adjustment .....	43
Selecting a Language .....	25	Adjust Stick Tension .....	43
Inactive Alarm .....	25	Mode Change Slider .....	44
Extra Settings .....	25	Programming Conversion .....	44
Serial Number .....	26	Calibrating .....	44
Exporting the Serial Number to the SD Card .....	26	<b>TROUBLESHOOTING GUIDE</b> .....	<b>45</b>
Locating the Transmitter Spektrum AirWare Software Version .....	26	<b>1-YEAR LIMITED WARRANTY</b> .....	<b>46</b>
Calibrate .....	26	<b>WARRANTY AND SERVICE CONTACT INFORMATION</b> .....	<b>47</b>
<b>Transfer SD Card</b> .....	<b>27</b>	<b>FCC INFORMATION</b> .....	<b>47</b>
Import Model .....	27	<b>ANTENNA SEPARATION DISTANCE</b> .....	<b>47</b>
Export Model .....	27	<b>IC INFORMATION</b> .....	<b>47</b>
Update AirWare Software .....	28	<b>FAA INFORMATION</b> .....	<b>47</b>
<b>FUNCTION LIST</b> .....	<b>29</b>	<b>AMA NATIONAL MODEL AIRCRAFT SAFETY CODE</b> .....	<b>47</b>
Servo Setup .....	29	<b>COMPLIANCE INFORMATION FOR THE EUROPEAN UNION</b> .....	<b>48</b>
Travel Adjust .....	29	<b>Instructions for disposal of WEEE by users in the   European Union</b> .....	<b>48</b>
Sub-Trim .....	29		



## INSTALLING THE TRANSMITTER BATTERIES

1. Remove the battery cover from the back of the transmitter.
2. Install the included 4 AA batteries into the battery holder.
3. Install the battery cover.

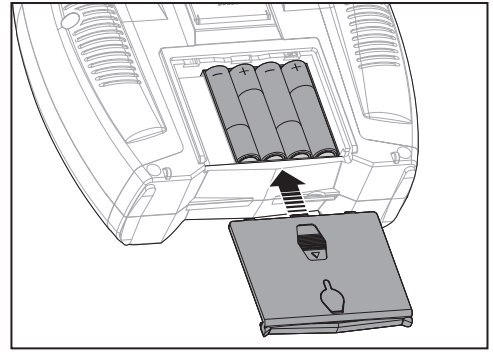

## INSTALLING OPTIONAL LITHIUM ION BATTERY PACK

1. Remove the battery cover from the back of the transmitter.
2. Remove the AA battery holder and disconnect from the transmitter power port.
3. Remove the rectangular foam and flat foam from the battery compartment.
4. Connect the battery pack (SPMA9602) to the transmitter power port.
5. Install the optional Li-Ion battery pack into the transmitter.
6. Install the battery cover.

**CAUTION:** When installing a Li-Ion battery pack, always set the battery chemistry to Li-Ion in the Systems Setting screen and correctly set the low voltage alarm.

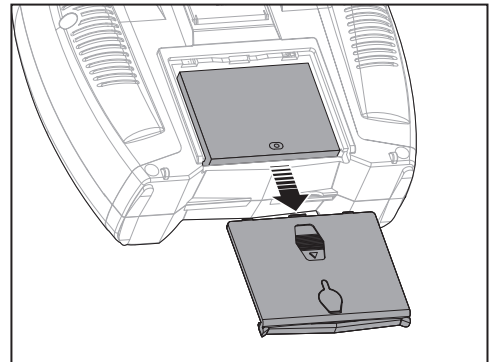

## CHARGING THE LITHIUM ION BATTERY PACK

The optional Li-Ion battery has an internal charger designed to quick charge at a rate of 0.5 amps. The charge port on the battery is not polarity-dependent.

**CAUTION:** Never connect an external battery charger to your DX8e transmitter.

Always charge the transmitter on a heat-resistant surface.

1. Power off your transmitter.
2. Connect the power supply (SPM9551) connector to the Li-Ion charge port located under the rubber flap on the battery door.
3. Connect the power supply to a power outlet using the appropriate adapter.
4. Disconnect the transmitter from the power supply once charging is complete and disconnect the power supply from the power outlet.

**CAUTION:** Never leave a charging battery unattended.

**CAUTION:** Never charge a battery overnight.

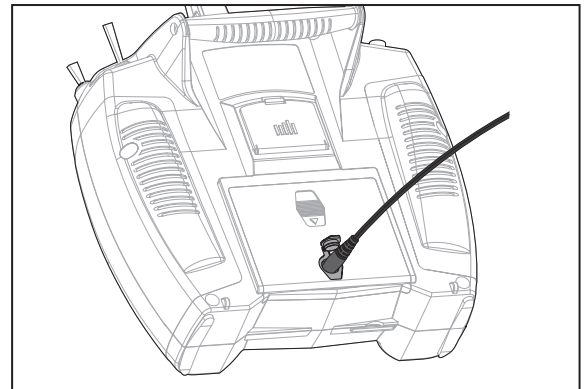

### Battery Alarm

The System Settings Screen allows you to change the battery type and low voltage alarm settings. See "System Settings" for more information.

- An alarm will sound when the battery reaches the low voltage limit (6.4V for LiPo/Li-Ion).

**CAUTION:** Never change the low voltage limit for LiPo/Li-Ion batteries from 6.4V. Doing so could over-discharge the battery and damage both battery and transmitter.

# TRANSMITTER FUNCTIONS

Function	
1	LED
2	Elevator Trim (Mode 2, 4) Throttle Trim (Mode 1, 3)
3	R Knob
4	Switch H
5	Switch G
6	Switch F
7	Throttle Tension Adjustment Throttle Ratchet Adjustment (Mode 1, 3)
8	Throttle/Aileron Stick (Mode 1) Elevator/Aileron Stick (Mode 2) Throttle/Rudder Stick (Mode 3) Elevator/Rudder Stick (Mode 4)

Function	
9	Left/Right Gimbal Stick Tension Adjustment
10	Up/Down Gimbal Stick Tension Adjustment
11	Aileron Trim (Mode 1, 2) Rudder Trim (Mode 3, 4)
12	Neck Strap Mount
13	Scroll wheel
14	LCD
15	Buzzer Grill
16	Back Button
17	Clear Button
18	Rudder Trim (Mode 1, 2) Aileron Trim (Mode 3, 4)

Function	
19	Throttle Tension Adjustment Throttle Ratchet Adjustment (Mode 2, 4)
20	Elevator/Rudder Stick (Mode 1) Throttle/Rudder Stick (Mode 2) Elevator/Aileron Stick (Mode 3) Throttle/Aileron Stick (Mode 4)
21	Left/Right Gimbal Stick Tension Adjustment
22	Up/Down Gimbal Stick Tension Adjustment
23	Switch D
24	Switch B
25	Switch A

Function	
26	Switch C
27	Bind/Switch
28	Elevator Trim (Mode 1, 3) Throttle Trim (Mode 2, 4)
29	On/Off Switch
30	Antenna

The transmitter comes with a thin, clear plastic film applied to some front panels for protection during shipping. Humidity and use may cause this film to come off. Carefully remove this film as desired.

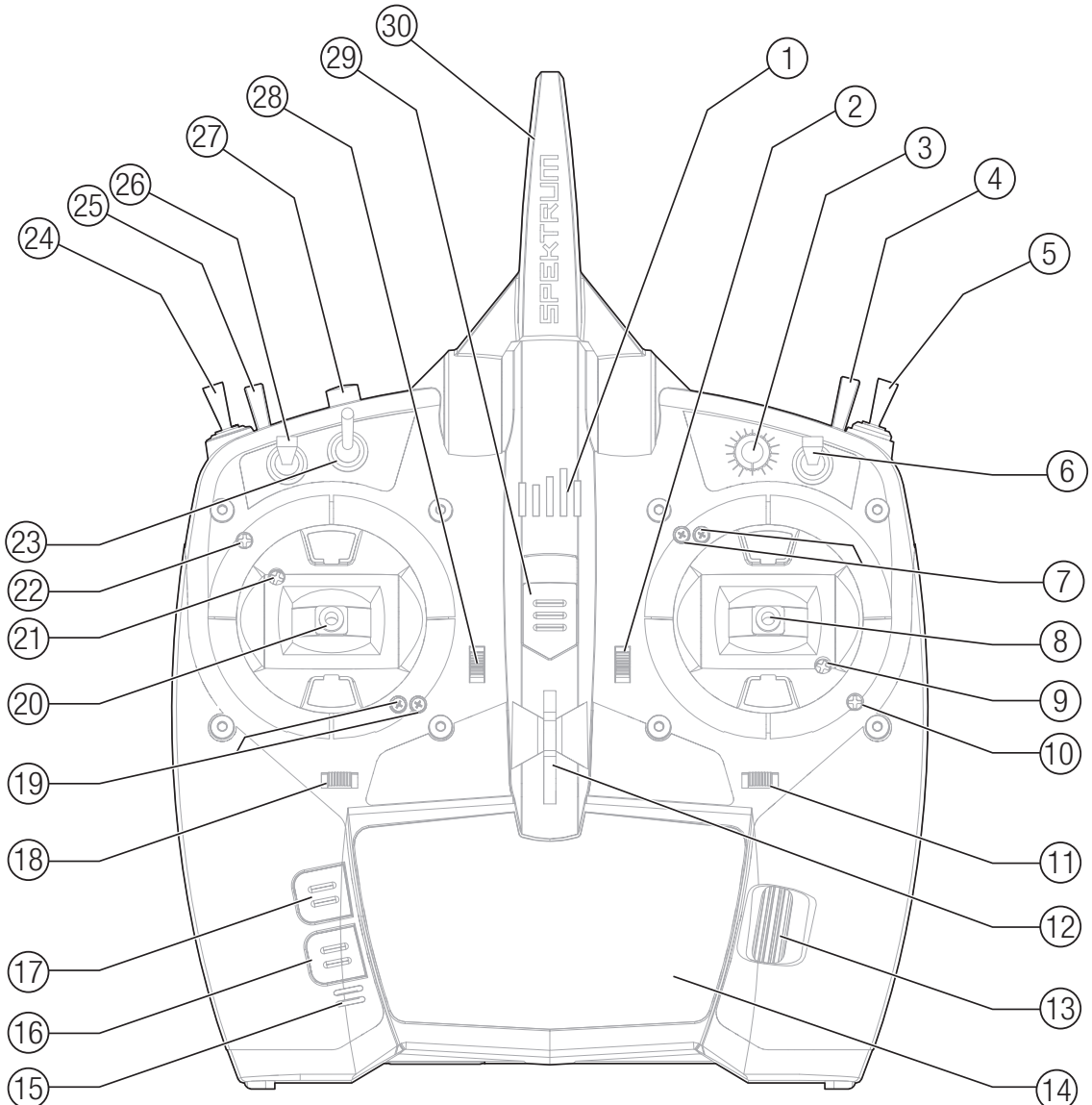

# TRANSMITTER FUNCTIONS

Function	
1	Bind Button
2	Switch A
3	Handle
4	Mode Change Slider
5	SD Card Opening

Function	
6	Charge Port for Use w/ Optional Lithium Ion Battery
7	Battery Cover
8	Mode Change Door
9	Antenna Rotation Tension

## Powering the DX8e On and Off

1. Press the power button to turn on the DX8e.
2. Press and hold the power button for about 4 seconds to power off the DX8e.

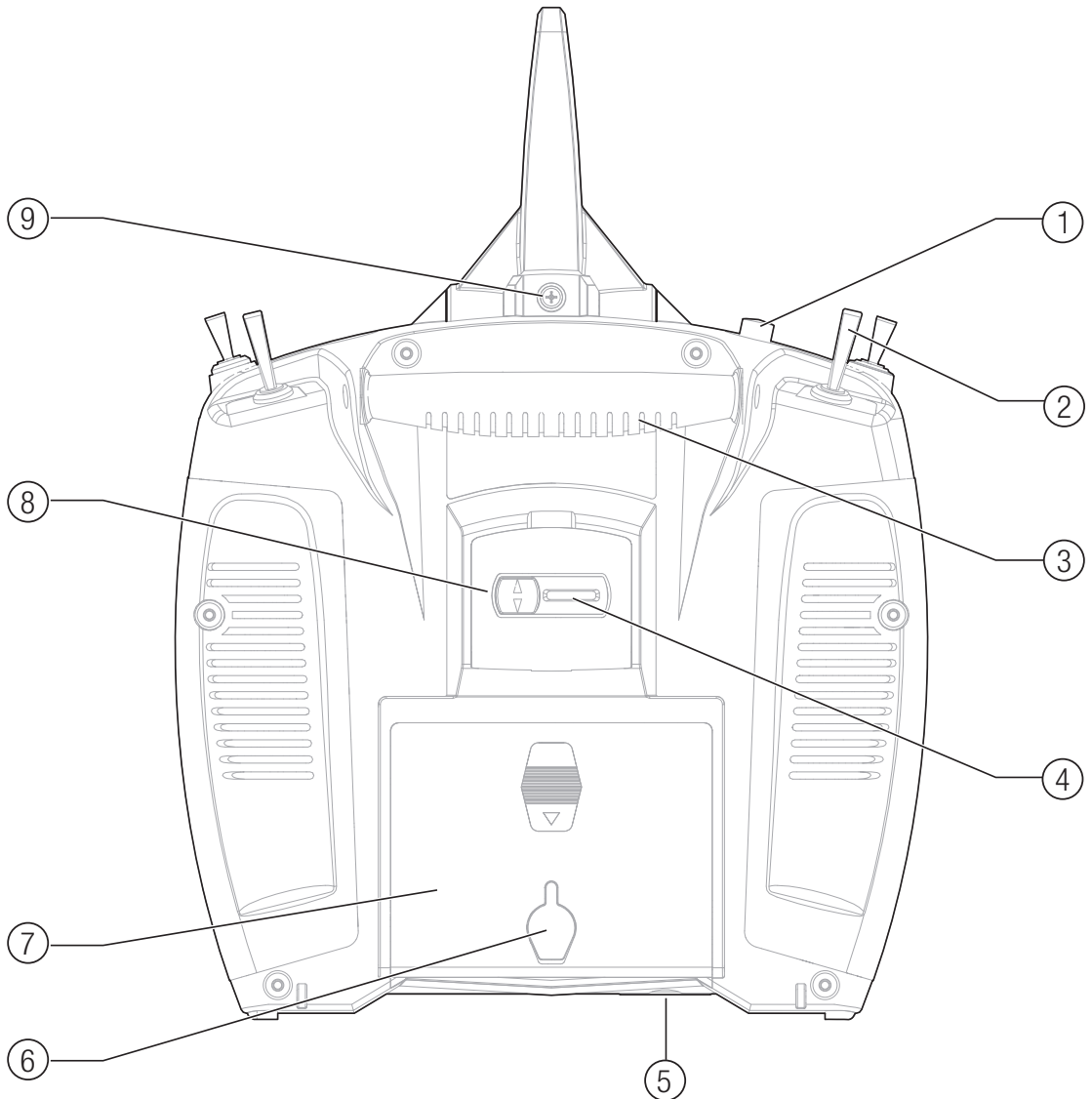
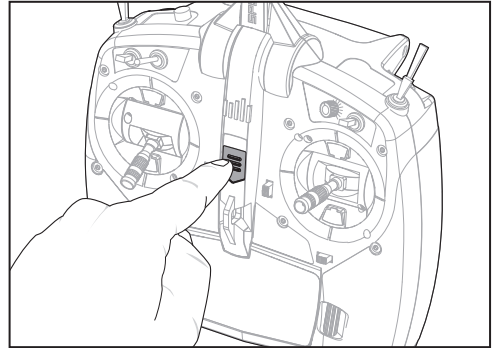



## MAIN SCREEN

Function	
(A)	Model Name
(B)	DSMX/DSM2 If not shown, this indicates not bound
(C)	Displays throttle position
(D)	Digital Battery Voltage ( <i>an alarm sounds and the screen flashes when battery charge gets down to 6.4V for a LiPo/Li Ion battery.</i> )
(E)	Model Avatar
(F)	Elevator Trim ( <i>Mode 2, 4</i> ) Throttle Trim ( <i>Mode 1, 3</i> )
(G)	Aileron Trim ( <i>Mode 1, 2</i> ) Rudder Trim ( <i>Mode 3, 4</i> )
(H)	Model Memory Timer

Function	
(I)	Rudder Trim ( <i>Mode 1, 2</i> ) Aileron Trim ( <i>Mode 3, 4</i> )
(J)	Throttle Trim ( <i>Mode 2, 4</i> ) Elevator Trim ( <i>Mode 1, 3</i> )
(K)	Timer

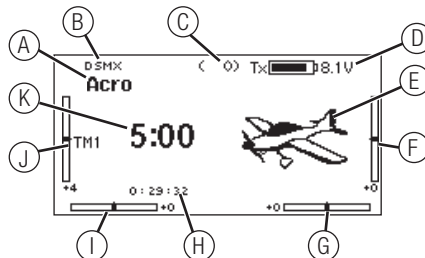

## NAVIGATION

- Scroll the scroll wheel to move through the screen content or change programming values. Press the scroll wheel to make a selection.
- Use the Back button to go to the previous screen (for example, to go from the Mixing Screen to the Function List).
- Use the Clear button to return a selected value on a screen to the default setting.
- Direct Model Access enables you to access the Model Select screen without powering off the transmitter. Anytime the transmitter power is on, press the Clear and Back buttons to access the Model Select screen.
- Press and hold the scroll wheel while powering on the transmitter to show the System Setup list. No radio transmission occurs when a System Setup screen is displayed, preventing accidental damage to linkages and servos during changes to programming.
- At the main screen you can scroll to view the servo monitor.
- The Main Screen appears when you power on the transmitter. Press the scroll wheel once to display the Function List.
- When you want to change a value in a screen for a particular control position, move the control to the desired position to highlight the value you want to change, such as 0/1/2, up/down or left/right.



**Tip:** The tick mark below shows the current switch position. Rolling and clicking the scroll wheel turns the selected box black, indicating that the value or condition will act on that position.

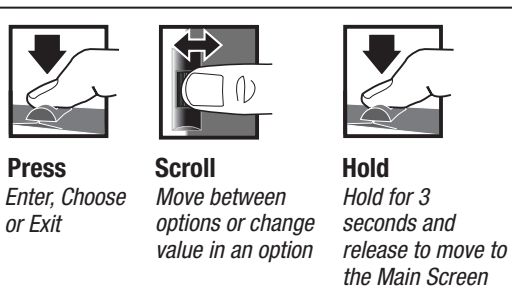

## Auto Switch Select

To easily select a switch in a function, such as a program mix, roll with the scroll wheel to highlight the switch selection box, and press the scroll wheel. The box around the switch should now flash. To select a switch, toggle the switch you wish to select. Verify the switch selection is now displayed as desired. When correct, press the scroll wheel to select this switch and complete the switch selection.

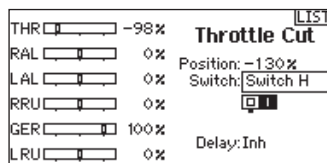

# SD CARD

## Installing an SD Card

An SD Card (not included) enables you to:

- Import (copy) models from any compatible\* Spektrum AirWare™ transmitter
- Export (transfer) models to any Spektrum AirWare transmitter\*
- Update Spektrum AirWare software in the transmitter
- Install/Update sound files
- Back up models for safe keeping

To install or remove a SD Card:

1. Power off the transmitter.
2. Remove the battery door.
3. Press the SD Card into the card slot with the card label facing up as shown.

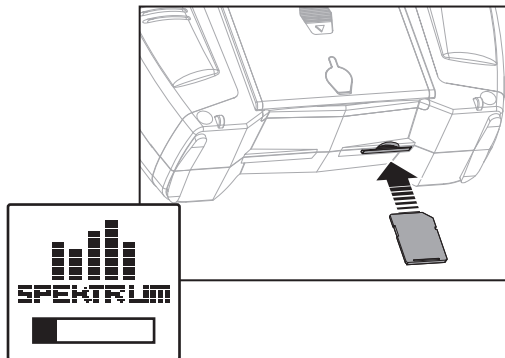

\*iX12, DX20, DX18t, DX18SE, DX18G2, DX18G1, DX18QQ, DX9Black, DX9, DX10t, DX8G2, DX7G2, DX6G3, DX6e and DX6G2

## Registering the Transmitter with Spektrum

Exporting the transmitter serial number to the SD Card allows you to upload the serial number directly into the registration screen at [www.spektrumrc.com](http://www.spektrumrc.com).

To export the serial number:

1. Press and hold the scroll wheel while powering the transmitter on until the System Setup list appears.
2. Scroll to the System Settings menu. Press the scroll wheel once to open the menu.
3. Select NEXT on the System Settings and Extra Settings screens.
4. When the Serial Number screen appears, select EXPORT.

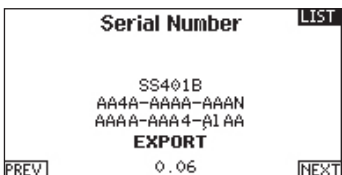

5. Power off the transmitter and remove the SD Card from the transmitter.

To Upload the serial number to [www.spektrumrc.com](http://www.spektrumrc.com):

1. Insert the SD Card in your computer and check the contents of the SD card on your computer for a "My\_DX8e.xml" file.
2. In your favorite browser navigate to [www.spektrumrc.com](http://www.spektrumrc.com) and find the Product Registration link on the top of the page as shown.

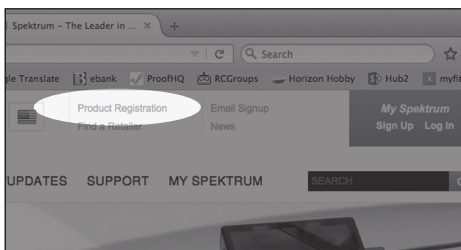

3. If you do not already have an account, create one now. If you have an account login in with your secure login.
4. Once logged in go to the "My Spektrum" page. Fill out all relevant information. Once you select your transmitter model from the pull down menu you will be asked to upload the serial number.
5. Click on the Select button to navigate to the "My\_DX8e.xml" file on the SD card that is in your computer's SD card reader and select the file.

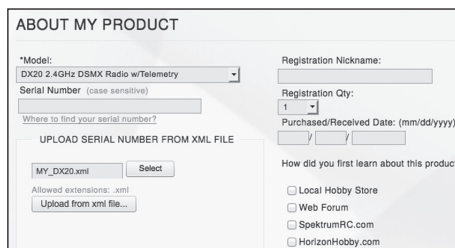

6. Click on the Upload from xml file... button and the serial number will populate into the Serial Number fields.
7. Click REGISTER at the bottom of the screen to finish registering your new Spektrum Transmitter.

Alternately you can copy the serial number from the .xml file and paste directly into the Serial Number field.

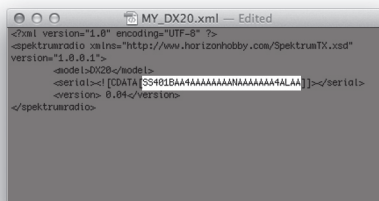

Screen shots from [www.spektrumrc.com](http://www.spektrumrc.com) are correct at time of printing but may change at a future date.

## SD CARD

### Update Spektrum AirWare™ Software

**NOTICE:** The orange LED Spektrum bars flash and a status bar appears on the screen when Spektrum AirWare software updates are installing. Never power off the transmitter when updates are installing. Doing so may damage the system files.

**NOTICE:** Before installing any Spektrum AirWare files, always Export All Models to an SD Card separate from the SD Card containing the update. The update may erase all model files.

For more information on Spektrum AirWare software updates, visit [www.spektrumrc.com](http://www.spektrumrc.com)

#### Automatically Installing Spektrum AirWare Software Updates

1. Go to [www.spektrumrc.com](http://www.spektrumrc.com). Under the Setups/Updates pull down tab, select the Firmware Updates link (shown).

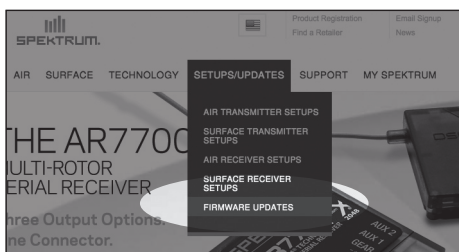

2. Log into your Spektrum account.
3. Find your registered transmitter in the MY PRODUCTS list and click on Download Updates. Follow directions on the screen for downloading the update to an SD card through your computer.

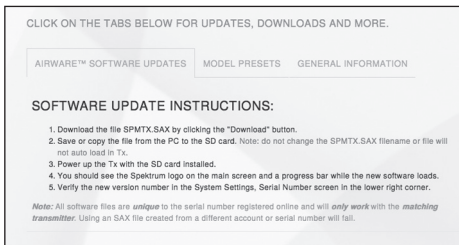
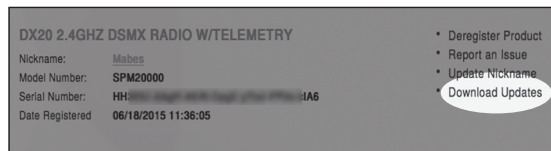

4. Eject the SD card from the computer.
5. Make sure the transmitter is powered off and install the SD card into the transmitter.
6. Power on the transmitter and the update automatically installs in the transmitter.

#### Manually Installing Spektrum AirWare Software Updates

1. Save the desired Spektrum AirWare version to an SD Card.
2. Install the SD card into the transmitter.
3. Select Update Firmware in the SD Card Menu options. The Select File screen appears.
4. Select the desired Spektrum AirWare version from the File List. When updates are installing, the transmitter screen is dark. The orange LED Spektrum bars flash and the update status bar appears on the screen.

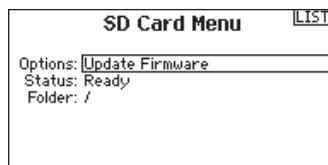

**NOTICE:** Do not power off the transmitter when updates are installing. Doing so will damage the transmitter.

Screen shots from [www.spektrumrc.com](http://www.spektrumrc.com) are correct at time of printing but may change at a future date.



## BINDING

Binding is the process of programming the receiver to recognize the GUID (Globally Unique Identifier) code of a single specific transmitter. You must bind the AR610 receiver to your transmitter before it will operate.

### Binding Using the Receiver and Receiver Battery

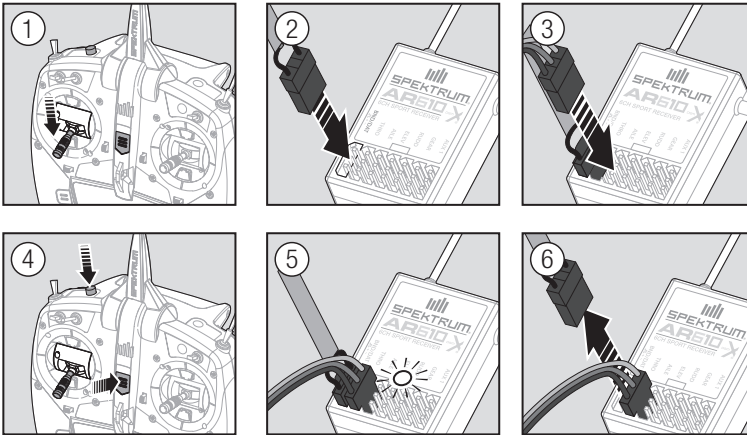

1. Lower throttle to the lowest position and make sure the transmitter is powered off.
2. Insert the bind plug into the BIND/DATA port.
3. Insert the receiver battery into ANY open port. The receiver's LED will flash when the receiver is ready to bind.
4. While pressing the Bind button, power on the transmitter.
5. Release the Bind button after the receiver has stopped flashing rapidly, once the receiver's LED stays illuminated; this indicates the receiver is bound to the transmitter. The screen also provides binding information.
6. Remove the bind plug from the receiver.

### Binding Using the Receiver and ESC

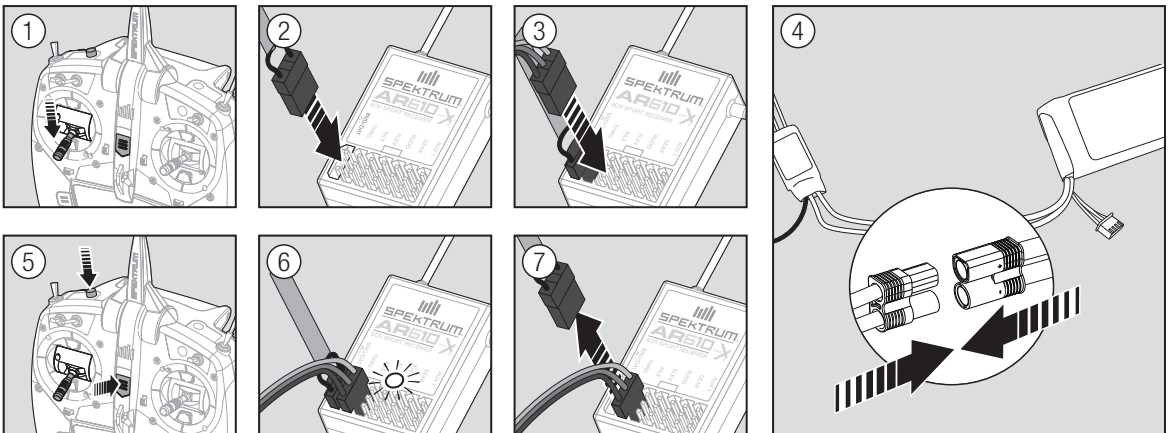

1. Lower the throttle to the lowest position and make sure the transmitter is powered off.
2. Insert the bind plug into the BIND/DATA port.
3. Insert the ESC plug into the THRO port.
4. Connect the battery to ESC and turn on the ESC switch, if available. The receiver's LED will flash rapidly when the receiver is ready to bind.
5. While pressing the Bind button, power on the transmitter.
6. Release the Bind button after the receiver's LED stays illuminated. This indicates the receiver is bound to the transmitter. The transmitter screen also provides binding information.
7. Remove the bind plug from the receiver.

## RECEIVER POWER SYSTEM REQUIREMENTS

Inadequate power systems that do not provide the necessary minimum voltage to the receiver during flight have become the number one cause of in-flight failures. Some of the power system components that affect the ability to properly deliver adequate power include:

- Receiver battery pack (number of cells, capacity, cell type, state of charge)
- The ESC's capability to deliver current to the receiver in electric aircraft
- The switch harness, battery leads, servo leads, regulators etc.

The AR8010T has a minimum operational voltage of 3.5 volts; test the power system per the guidelines below.

### Recommended Power System Test Guidelines

If you are using a questionable power system, (e.g. a small or old battery, an ESC that may not have a BEC that will support high-current draw, etc.), perform the following test with a voltmeter. The Hangar 9<sup>®</sup> Digital Servo and Receiver Current Meter (HAN172) or the Spektrum Flight Log (SPM9540) work well for this test.

Connect the voltmeter to an open channel port in the receiver and, with the system on, load the control surfaces (apply pressure with your hand) while monitoring the voltage at the receiver. The voltage should remain above 4.8 volts, even when all servos are heavily loaded.



**CAUTION:** When charging Ni-MH batteries, make sure the battery fully charges. Ni-MH batteries charged with peak detection fast chargers have a tendency to false peak (i.e. not fully charge), which could lead to a crash.

### European Union Receiver Requirements

EU versions of the DX8e are not compatible with DSM2<sup>®</sup> receivers. Make sure all receivers are DSMX<sup>®</sup> compatible.

### QuickConnect™ Technology with Brownout Detection (DSM2 Only)

The AR8010T features QuickConnect technology with Brownout Detection.

- Should an interruption of power occur (brownout), the system will reconnect immediately when power is restored.
- The LED on the receiver will flash slowly, indicating a power interruption (brownout) has occurred.
- Brownouts can be caused by an inadequate power supply (weak battery or regulator), a loose connector, bad switch, inadequate BEC when using an electronic speed controller, etc.
- Brownouts occur when the receiver voltage drops below 3.5 volts. This interrupts control, as the servos and receiver require a minimum of 3.5 volts to operate.

### How QuickConnect Technology with Brownout Detection Works

- When the receiver voltage drops below 3.5 volts, the system drops out (ceases to operate).
- When power is restored, the receiver immediately attempts to reconnect to the last two frequencies it was connected to.
- If the two frequencies are present (the transmitter was left on), the system reconnects typically in about 4/100 of a second.

QuickConnect with Brownout Detection is designed to allow you to fly safely through most short duration power interruptions. However, you must correct the cause of these interruptions before your next flight to prevent a crash.



**CAUTION:** If a brownout occurs in flight, determine the cause of the brownout and correct it before attempting to fly again.

## PROGRAMMING FAILSAFE POSITIONS

You establish failsafe positions when you bind your transmitter and receiver. If the radio signal connection is lost between the transmitter and receiver, the receiver immediately moves the aircraft control surfaces to the failsafe positions. If you assign the receiver THRO channel to a transmitter channel other than throttle, we recommend using Preset failsafe with the throttle in the low position.

**NOTICE:** Failsafe features vary according to receiver. Always consult the receiver instruction manual for failsafe features.

Before flight, ALWAYS confirm the failsafe functions as you would expect.

### SmartSafe™ Failsafe

SmartSafe failsafe is a technology that only acts on the throttle channel and offers the following benefits:

- Prevents electric motors from operating when the receiver power is on and the transmitter power is off.
- Prevents the speed controller from arming until the throttle is moved to the low throttle position.
- Powers off an electric motor and reduces gas/glow engines to idle if signal is lost.

To Program SmartSafe, move the throttle to the low or off position before putting the transmitter into bind mode.

To Test the SmartSafe failsafe:

1. Power the transmitter and receiver on.
2. Power off the transmitter. The throttle should immediately move to the failsafe position.

 **CAUTION:** Make sure the aircraft is fully restrained on the ground. If the failsafe is not set correctly, your aircraft might advance to mid or full throttle.

### Hold Last Command

The Hold Last Command failsafe maintains the last command on all channels except throttle. If the radio signal is lost, the aircraft maintains the commanded control inputs until the receiver regains signal.

To program Hold Last Command, follow the provided binding instructions in this manual.

To Test Hold Last Command:

1. Power on the transmitter and receiver.
2. Move one of the control sticks to the desired Hold Last Command position and hold the input.
3. While holding the control input (for example, a small amount of rudder) power off the transmitter. The rudder should maintain the input command.

 **CAUTION:** Make sure the aircraft is fully restrained on the ground. If the failsafe is not set correctly, the aircraft throttle might advance to mid or full throttle.

### Preset Failsafe

The Preset failsafe moves all channels to their programmed failsafe positions.

We recommend using Preset failsafe to deploy spoilers on sailplanes to prevent a flyaway if the radio signal is lost.

To program Preset failsafe:

1. Insert the bind plug in the bind port on the receiver and power on the receiver.
2. Remove the bind plug when the orange LED on the main receiver and all attached remote receivers flash rapidly. The orange receiver LEDs will continue flashing.

3. Move the transmitter control sticks and switches to the desired Preset failsafe position. Power the transmitter on.
4. Failsafe programming is complete when the orange LEDs on the transmitter and all receivers turn solid.

 **CAUTION:** Make sure the aircraft is fully restrained on the ground. If the failsafe is not set correctly, the aircraft throttle might advance to mid or full throttle.

**IMPORTANT:** Not all receivers support Preset Failsafe. Consult your receiver manual for more information.



## MODEL TYPE PROGRAMMING GUIDE

Menu options show up on model type selection. These menu options vary between Model Types (Airplane, Helicopter, Sailplane and Multirotor), but are identical for all models in that type. Subsequent aircraft type (Aircraft, Swashplate, Sailplane or Multirotor) selections make other menu options appear.



System Setup List:	Function List:
Model Select	Servo Setup
<b>Model Type</b>	D/R and Expo
Model Name	→ Differential
<b>Aircraft Type</b>	→ V-Tail Differential
F-Mode Setup	Throttle Cut
Spoken Flight Mode	Throttle Curve
Channel Assign	→ AS3X Gains
Trim Setup	→ Flap System
Model Utilities	Mixing
Warnings	Range Test
Telemetry	Timer
Preflight Setup	Telemetry
Frame Rate	Custom Voice Setup
Bind	System Setup
Trainer	Monitor
Digital Switch Setup	
Sound Utilities	
System Settings	



System Setup List:	Function List:
Model Select	Servo Setup
<b>Model Type</b>	D/R and Expo
Model Name	→ Differential
<b>Sailplane Type</b>	→ V-Tail Differential
F-Mode Setup	Throttle Cut
Spoken Flight Mode	→ Motor Curve
Channel Assign	→ AS3X Gains
Trim Setup	→ Camber Presets
Model Utilities	→ Camber System
Warnings	Mixing
Telemetry	Range Test
Preflight Setup	Timer
Frame Rate	Telemetry
Bind	Custom Voice Setup
Trainer	System Setup
Digital Switch Setup	Monitor
Sound Utilities	



System Setup List:	Function List:
Model Select	Servo Setup
<b>Model Type</b>	D/R and Expo
Model Name	Throttle Cut
<b>Swashplate Type</b>	Throttle Curve
F-Mode Setup	Pitch Curve
Spoken Flight Mode	→ Swashplate
Channel Assign	Gyro
Trim Setup	Tail Curve
Model Utilities	Mixing
Warnings	Range Test
Telemetry	Timer
Preflight Setup	Telemetry
Frame Rate	Custom Voice Setup
Bind	System Setup
Trainer	Monitor
Digital Switch Setup	
Sound Utilities	
System Settings	
Transfer SD Card	



System Setup List:	Function List:
Model Select	Servo Setup
<b>Model Type</b>	D/R and Expo
Model Name	Throttle Cut
<b>Aircraft Type</b>	Throttle Curve
F-Mode Setup	Pitch Curve
Spoken Flight Mode	→ Camera Gimbal
Channel Assign	Motor Cut
Trim Setup	Motor Curve
Model Utilities	Mixing
Warnings	Sequencer
Telemetry	Range Test
Preflight Setup	Timer
Frame Rate	Telemetry
Bind	Custom Voice Setup
Trainer	System Setup
Analog Switch Setup	Monitor
System Settings	
Model Utilities	
Transfer SD Card	

## SYSTEM SETUP

Press and hold the scroll wheel while powering on the transmitter to show the System Setup list. No radio transmission occurs when a System Setup screen is displayed, preventing accidental damage to linkages and servos during changes to programming.

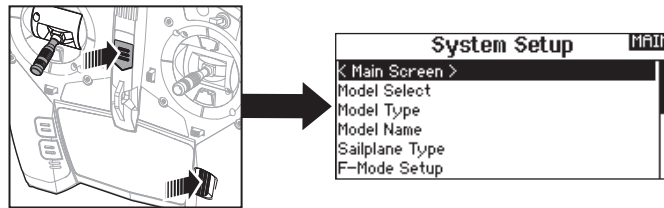

You can also enter the System Setup from the Function list without turning the transmitter off. A Caution screen will appear that warns that RF will be disabled (the transmitter will no longer transmit). Press YES if you are sure and want to access the System List. If you are not sure, press NO to exit to the main screen and continue operation.

If you do not press YES or NO, the system will exit to the main screen and continue operation within approximately 10 seconds.

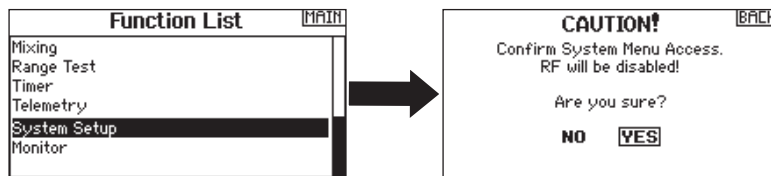

**WARNING:** Do not press YES unless the model is turned off or the model is secured.

## Model Select

Model Select enables you to access any of the 250 internal model memory locations in the Model Select list.

1. Scroll to the desired model memory in the Model Select list.
2. When the desired model memory is highlighted, press the scroll wheel once to select the model. The transmitter returns to the System Setup List.
3. Add a new model by rolling to the bottom of the list. You will then be prompted with the Create New Model screen, with the option to create a new model or cancel. If you select Cancel, the system will return to the Model Select function. If you select Create, the new model will be created and now be available in the model select list.

### Direct Model Access

Press the Clear and Back buttons from the Main Screen or a telemetry screen to access Model Select.

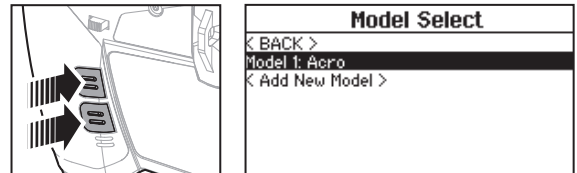

## Model Type

Select from Airplane, Helicopter, Sailplane or Multicopter model types.

**IMPORTANT:** When you select a new model type, you will delete any programming data in the current model memory. Always confirm the desired model memory before changing model types. It will be necessary to re-bind after resetting the model type.

To change the model type:

1. Scroll to the desired model type and press the scroll wheel. The Confirm Model Type screen appears.
2. Select Yes and press the scroll wheel to confirm the model type. All data will be reset. Selecting No will exit the Confirm Model Type screen and return to the Model Type screen.

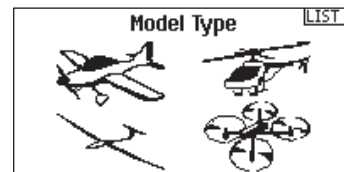

## SYSTEM SETUP

### Model Name

Model Name enables you to assign a custom name to the current model memory. Model names can include up to 20 characters, including spaces.

To add letters to a Model Name:

1. Scroll to the desired letter position and press the scroll wheel once. A flashing box appears.
2. Scroll left or right until the desired character appears. Press the scroll wheel once to save the character.
3. Scroll to the next desired letter position. Repeat Steps 1 and 2 until the Model Name is complete. Insert a character by selecting <+> or delete a character by selecting <->.
4. Select BACK to return to the System Setup list.

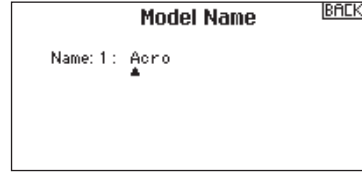

To erase a character:

1. Press CLEAR while the character is selected.
2. Press CLEAR a second time to erase all characters to the right of the cursor.

### Aircraft Type

▶ This menu only available in Airplane Mode. See ACRO (Airplane) section for set up.

### Sailplane Type

▶ This menu only available in Sailplane Mode. See SAIL (Sailplane) section for set up.

### Swash Type

▶ This menu only available in Helicopter Mode. See HELI (Helicopter) section for set up.

### Aircraft Options

▶ This menu only available in Multirotor Mode. See MULTI (Multirotor) section for set up.

## F-Mode Setup

Use the Flight Mode Setup menu to assign switches to flight modes.

Mode	Number of Switches	Number of Flight Modes
ACRO	2	5
HELI	3 (including Throttle Hold)	5 (including Throttle Hold)
SAIL	3	10
MULTI	2	5

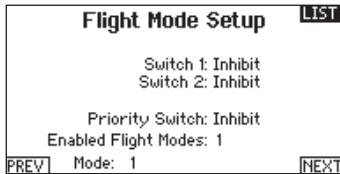

### Sailplane Flight Mode Setup

You can assign up to five flight modes using any combination of up to two switches. You can also assign a priority switch. When the priority switch position is active, only the current flight mode is active, regardless of other switch positions.

### Sailplane Flight Mode Table

You can assign the available flight modes (up to 5 for Sail) to each of the switch positions (up to 2 switches can be used for sailplane). Press NEXT from the Flight Mode Name page to access the flight mode table assignment page when Custom flight mode has been selected in the Flight Mode Setup page. The combination of up to 2 switches can be used to access all of the flight modes available.

Number of Flight Modes	2	3	3*	4	4	5
Switch 1 (number of positions)	2P	3P	2P	2P	3P	3P
Switch 2 (number of positions)			2P	3P	2P	3P
Flight Mode 1	Launch	Launch	Launch	Launch	Launch	Launch
2	Cruise	Cruise	Cruise	Cruise	Cruise	Cruise
3		Land			Land	Land
4			Thermal	Thermal	Thermal	Thermal
5				Speed		Speed

\*Must be set up in a 4/5 flight mode.



## SYSTEM SETUP

### Flight Mode Setup

Enables you to assign custom names to the Flight Mode positions. Flight Mode names can include up to 20 characters, including spaces.

To change the Flight Mode name:

1. Scroll to the Flight Mode name you wish to change and press the scroll wheel.
2. Scroll to the character position you wish to change and press the scroll wheel once. A flashing box appears.
3. Scroll left or right until the desired character appears. Press the scroll wheel once to save the character. Insert a character by selecting <+> or delete a character by selecting <->.
4. Repeat Steps 2 and 3 until the Model Name is complete.
5. Select BACK to return to the Flight Mode Names list.

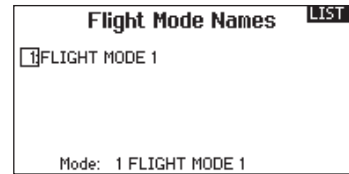

### Channel Assignment

The Channel Assignment function allows you to reassign almost any receiver channel to a different transmitter channel. For example, the receiver gear channel could be re-assigned to the transmitter throttle channel.

1. Scroll to the receiver channel you wish to change.
2. Press the scroll wheel once and scroll left or right to change the receiver input selection.
3. Press the scroll wheel a second time to save the selection.

**IMPORTANT:** You cannot assign a mix to a channel that has been moved. Create the mix first, then move the channel.

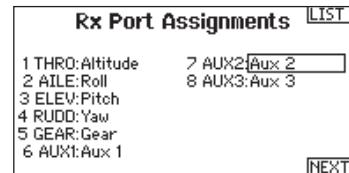

### Channel Input Configuration

The Channel Input Configuration screen enables you to assign a transmitter channel to a different control stick or switch.

1. Select NEXT on the RX Port Assignments screen to access the Channel Input Configuration screen.
2. Scroll to the transmitter channel you wish to re-assign and press the scroll wheel. The box around the current input selection flashes.
3. Scroll left or right to select the desired control stick or switch.
4. Press the scroll wheel to save the selection.

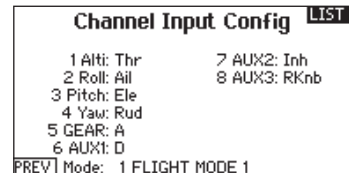

## SYSTEM SETUP

### Trim Setup

Use the Trim Setup screen to change the size of the trim step and the trim type.

#### Trim Step

Adjusting the trim step value determines how many “clicks” of trim you input each time you press the trim button. Changing the trim step value to 0 disables the trim for the channel.

To change the trim step value:

1. Scroll to the trim step channel you wish to change.
2. Select the trim step value and scroll left or right to change the value.
3. Press the scroll wheel to save the selection.

#### Trim Type

The two Trim Type options are *Common* and *F Mode*.

**Common** trim type maintains the same trim values for all flight modes.

**F Mode** trim type enables you to save trim values for individual flight modes if you find, for example, the aircraft requires aileron trim in Flight Mode 1 but not in Flight Mode 2.

#### Trim Assignment

In a few instances, you can reassign a trim to a different location.

#### Aircraft Model Type

Throttle

- Throttle Digital trim button (default)

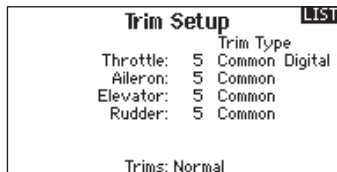

#### Throttle Trim Type

- Common
- Flight Mode

#### Trim Location

Normal and Cross trim types are available. Normal trims align with the control stick; for example, the throttle trim is next to the throttle stick.

Cross trims reverse the position of the trims; for example, the throttle trim is next to the elevator stick and vice versa.

To change the Trim Position from Normal to Crossed, select Normal at the bottom of the Trim Setup screen and press the scroll wheel.

**IMPORTANT:** Crossed trims will cross both sets of trims for both gimbals.

### Model Utilities

In the Model Utilities function you can create a new model, delete a model, copy a model, reset a model to default settings and sort the model list.



#### ► Create New Model

Use this selection to create a new model in the model select list.

1. Select Create New Model. Within this screen, you will have the option to create a new model or cancel.
2. If you select Cancel, the system will return to the Model Select function.
3. If you select Create, the new model will be created and now be available in the model select list.



#### ► Delete Model

Use this selection to permanently delete a model from the model select list. If you do not wish to delete a model, select Cancel to exit the page.

1. To delete a model, highlight the model listed. Press to select, then roll to the model name. Press the scroll wheel to select.
2. Select DELETE to delete the model.

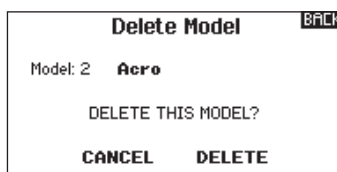

## SYSTEM SETUP

### ► Copy Model

The Model Copy menu enables you to duplicate model programming from one Model List location to another.

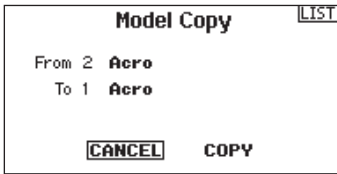

Use Model Copy to:

- Save a default model copy before experimenting with programming values
- Expedite programming for a model using a similar programming setup

**IMPORTANT:** Copying a model program from one model memory to another will erase any programming in the “To” model memory.

To copy model programming:

1. Make sure the model program you wish to copy is active. If the desired model program is not active, select Cancel and change the active model in the Model Select menu.
2. Select the model memory next to “To” and scroll to the desired model memory. Press the scroll wheel once to save the selection.
3. Select Copy and the Confirm Copy screen appears.
4. Select Copy to confirm. Selecting Cancel will return to the System Setup screen.
5. Select the “To” model as the current model, then bind the transmitter and receiver. Copying a model does not copy the bind from the original model.

You cannot use the Model Copy screen to copy model programming to an SD Card. To copy model programming to the SD Card, please see “Transfer SD Card”.

### ► Model Reset

Use the Model Reset menu to delete all model programming in the active model memory. Reset returns all model settings to the default settings and erases all programming in the selected model.

After a model reset, it is necessary to re-bind.

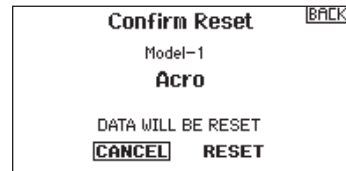

### ► Sort Model List

With this function you can sort the model order in the model select function. This is helpful to group similar models together to make them easy to find. To move a model, highlight the model that you wish to move with the scroll wheel, then press the scroll wheel to select it. Scroll the scroll wheel to move the selected model to the position desired. Press the scroll wheel when you have the model in the position desired.

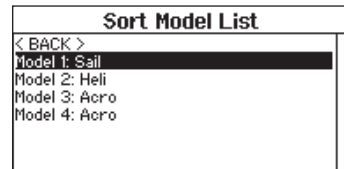

## Warnings

The Warnings menu enables you to program a voice, tone or vibration alert during power on of the transmitter for any selected switch or channel position.

The alarm activates and an alert message appears on the screen if a specific switch or control stick is in an unsafe position when you power the transmitter on.

Return the switch or control stick to the safe position to silence the alarm.

For safety reasons, the default throttle alarm activates if the throttle position is above 10%.

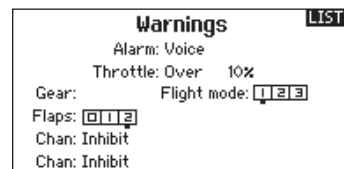

# SYSTEM SETUP

## TELEMETRY

Installing the optional telemetry module and sensors enables the display of aircraft performance data on the transmitter screen.

You can also enable Data Logging to save a telemetry file on the SD Card and view the data in the Spektrum STi™ mobile application.

### ► Telemetry Settings

#### Display

Telemetry display options include:

**Tele:** When you press the scroll wheel, the Telemetry screens appear and the Main Screen is disabled.

**Main:** Telemetry alerts appear on the Main screen, but all Telemetry screens are disabled.

**Roller (Default):** Allows you to toggle between the Telemetry screens and the main screen by pressing the scroll wheel.

**Auto:** The Telemetry screen automatically appears as soon as the transmitter receives data from the telemetry module.

#### Units

Scroll to Units and press the scroll wheel to change between US and Metric.

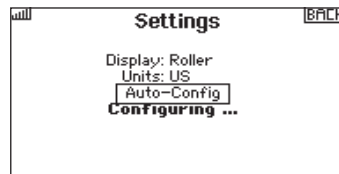
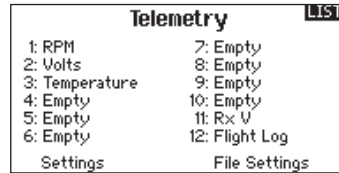

### ► Telemetry Auto-Configuration

**IMPORTANT:** The Auto-Config option is not available from the System Setup>Telemetry menu. RF signal must be transmitting when you use the Auto-Config option. When the System Setup menu is active, RF signal is off.

The DX8e transmitter features telemetry Auto-Configuration, allowing the transmitter to detect new telemetry sensors.

#### To use Telemetry Auto-Config:

1. Make sure all telemetry components are bound to the transmitter and receiver.
2. Power on the transmitter, then power on the receiver.
3. Select Telemetry from the Function List, then select Auto Config. "Configuring" flashes for 5 seconds and any new sensors appear in the list.
4. Adjust the sensor alert values as necessary.

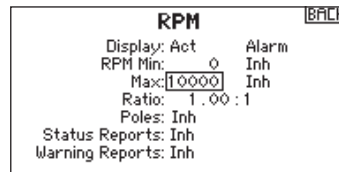

#### Status Reports:

Status Reports determines how often the transmitter refreshes the data on the screen. Each telemetry sensor can be adjusted independently.

For example, the RPM status report can refresh every 10 seconds while the altimeter sensor refreshes every 15 seconds.

#### Warning Reports:

Warning Reports determines how often a telemetry alert occurs, if an alert is active.

### ► AS3X Gain Live View (ACRO and SAIL Types Only)

When using an AS3X receiver (AR636, AR6335, AR9350, etc.), AS3X Live Gain View allows:

- Real time display of gain values for Roll, Pitch and Yaw
- Gains to be adjusted from the roller
- Selection of the channel that is used to adjust gains (must match application)
- Selection of the switch that is used to change flight modes

#### To activate AS3X Gain Live View:

1. Enter the Telemetry screen from either the Function List or the System Setup list.
2. Scroll to the desired "Empty" channel to use for gain adjustment.
3. Press and scroll to select AS3X. The AS3X Gain menu is now available in the Function List.

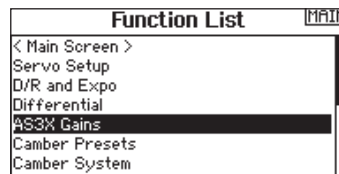
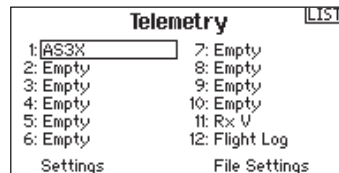

## SYSTEM SETUP

### ► Telemetry Alarms

Select Inh under Alarm to select the type of alarm desired. Options include **Inh** and **Tone**.

### File Settings

This is used to select the data logging settings.

#### File Name

1. Select File Name to assign a custom file name.
2. The File Name screen appears, allowing you to name the file as you would for a Model Name or Flight Mode Name. The file name can include a maximum of 8 characters.
3. Press BACK to save the name.

#### Start

1. Select Start to assign a specific switch position or stick position that activates Data Logging.
2. Press the scroll wheel once to save the selection.

### Enabled

When Enabled is set to NO, Data Logging is turned off. Select YES to save Telemetry data to the SD Card. The SD Card must be installed in the transmitter to select YES.



**CAUTION:** If you access the Telemetry menu from the Function List, you may see a Frame Loss appear when you exit the menu. The Frame Loss is not an error, but there will be a momentary loss of radio signal when exiting the Telemetry screen. **DO NOT** access the Telemetry menu during flight.

## Preflight Setup

The Preflight Setup menu option enables you to program a pre-flight checklist that appears each time you power on the transmitter or when you select a new model memory. Each item on the list must be confirmed before you can access the Main Screen.



## Frame Rate

The Frame Rate menu enables you to change the frame rate and modulation mode. Select the option you wish to change and press the scroll wheel.

You must use digital servos if you select 11 ms frame rate. Analog and digital servos can be used with a 22ms frame rate.

### Modulation Mode

We recommend using DSMX® (default) modulation mode. When DSMX is active, the transmitter operates in DSMX with DSMX receivers and DSM2\* with DSM2® receivers. The transmitter automatically detects DSM2 or DSMX during binding and changes the mode accordingly to match the receiver type you are using. If you select DSM2, the transmitter operates in DSM2 regardless of whether it is bound to a DSM2 or DSMX receiver.

\*DSM2 is not available in the EU.

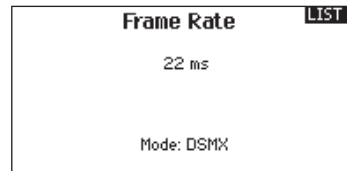

**NOTICE:** While DSMX allows you to use more than 40 transmitters simultaneously, do not use more than 40 transmitters simultaneously when using a DSM2 receiver or a transmitter in DSM2 mode.

**NOTICE:** For EU versions, DSM2 operation is not available.

## Bind

The Bind menu enables you to bind a transmitter and receiver without powering off the transmitter. This menu is helpful if you are programming a model and need to bind the receiver for failsafe positions.

See “Programming Failsafe Positions” for more information.

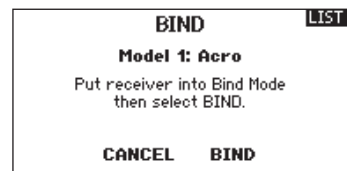



## SYSTEM SETUP

### ▶ Wireless Trainer

Wireless Trainer works just like the Wired Trainer, without the wire. Select Wireless Trainer to bind a DSM2 or DSMX slave transmitter to the master transmitter. With this option, when the master presses the trainer button or switch, control is given to the currently bound slave transmitter. After binding, the slave transmitter will remain bound to the master transmitter until a different transmitter is bound to the master, or the slave transmitter is bound to another receiver or a wireless master transmitter. ModelMatch™ technology applies to the wireless trainer system; the master transmitter will be bound to the slave in the bound model used. Also, if the slave transmitter has ModelMatch technology, it will only be bound to the master transmitter in the selected model during binding.

#### Inhibit

In Inhibit, the wireless trainer function will be inhibited and will not function.

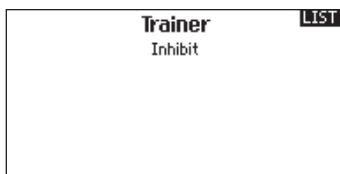

**CAUTION:** Select Inhibit in the Trainer menu when you aren't using the wireless trainer function. Failure to select Inhibit may result in loss of control of the aircraft.

#### Programmable Master

Programmable mode enables you to program the master transmitter to transfer any or all individual channels when you activate the trainer switch. This mode is ideal for beginners learning to control individual channels while the master transmitter maintains control of all other channels. The slave transmitter should be in Inhibit mode, if available. The Master and Slave transmitters **MUST** have the same programming.

#### Pilot Link Master

Pilot Link Master enables you to program the master transmitter to transfer any or all individual channels when you activate the trainer switch. Pilot Link Master is ideal for complex models, as the master transmitter maintains control of all secondary functions, such as flight modes, retracts, flaps and brakes.

**Secondary functions can be individually assigned to the Slave transmitter as necessary. It is not necessary to have model programming in the slave transmitter.**

### DX8e Wireless Trainer Operation

1. Enter an unused model on the slave transmitter (computer transmitter only).
2. Bind the master transmitter to the model.
3. Make sure the master and slave transmitter battery packs are fully charged.
4. Make sure the slave transmitter is powered off.
5. Either in the Wireless Programmable Master setup page or the Wireless Pilot Link Master setup page, select BIND. This will put the master transmitter's wireless trainer receiver into bind mode. You should see the following screen:

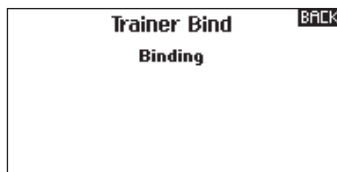

6. Enter bind mode on the slave transmitter following the instructions provided with that transmitter.
7. After a successful bind, the following screen should appear:



8. Press the trainer button on the master transmitter to transfer model control from the master to the slave.
9. Release the trainer button and the master transmitter regains control of the model.

#### Master Override

The Master Override feature enables the instructor to immediately regain control of the model by moving the control sticks. After you activate Master Override, the slave transmitter cannot control the model until you reset the trainer switch. To reset the trainer switch:

1. Move the trainer switch to the OFF position.
2. Move the trainer switch to the ON position to activate the slave transmitter.

## SYSTEM SETUP

### ▶ Trainer FPV Mode

The Trainer FPV function enables you to control FPV head-tracking in wireless mode. You may assign incoming head-tracker channels to any available output channel in the transmitter.

To use the FPV mode:

1. Change the trainer mode from Inhibit to FPV.
2. Select the switch you wish to use for the head tracker, then select NEXT.
3. Select the Output Channel where the head tracker servo is connected.
4. Change Mode: Master to Mode: Slave.
5. Select Input Channel.
6. Test the head tracker movement. Move the head tracker switch to the On position, then move your head. The camera should move accordingly.
7. Adjust the Scale value to change the amount of camera movement. If the camera moves in the wrong direction, change the Direction option from Normal to Reverse.

**IMPORTANT:** Consult local laws and ordinances before operating FPV (first person view) equipment. In some areas, FPV operation may be limited or prohibited. You are responsible for operating this product in a legal and responsible manner.

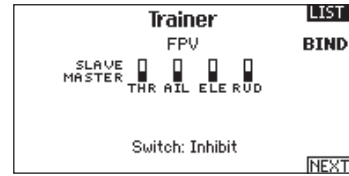

### Digital Switch Setup

Digital Switch Setup allows you to define the position values of each digital switch and flight mode switch. The switch can be assigned to a channel in the Channel Input Config function, and the output of the channel set in the Digital Input Setup screen. Additionally, the Flight Mode switch can have position values defined for each flight mode, and may be used as a mix input or channel input source, with the values defined in Digital Input Setup.

To use the Digital Switch Setup function:

1. Enter the Digital Input Setup screen, and press the roller with Inhibit selected.
2. Roll to select the switch or Flight Mode switch and press to select.
3. Roll to the desired position to adjust, and press the roller to select.
4. Roll to select the desired value, then press to select.
5. Repeat step 4 and 5 for all positions that you wish to adjust.
6. If you want to select a switch to control a channel, roll to select Channel: Inhibit on the bottom of the screen and press the roller. This will take you to the Channel Input Config screen to assign a channel to a switch.
7. Repeat 2 through 6 for all switches desired.

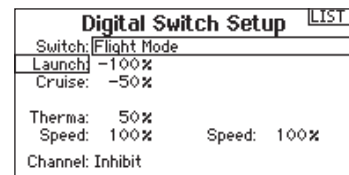
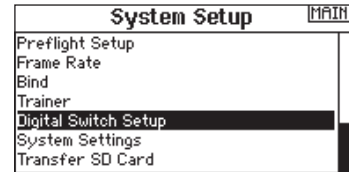

**IMPORTANT:** After you exit the Digital Input Setup screen, the return screen will show Inhibit at the top of the screen. If you wish to adjust a previously set value, select the switch and the previously set values can then be viewed and re-adjusted as desired.

# SYSTEM SETUP

## SYSTEM SETTINGS

The System Settings menu consists of four screens:

System Settings, Extra Settings, Serial Number and Calibrate.

Select NEXT or PREV to move between screens.

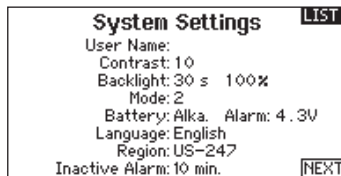

### ► User Name

The User Name field displays your name in the lower right corner of the main screen.

To Program a User Name:

1. Scroll to User Name and press the scroll wheel. The User Name screen appears.
2. Scroll to the desired character position and press the scroll wheel. Scroll left or right to change the character and press the scroll wheel to save the selection. The User Name can contain a maximum of 20 characters, including spaces.
3. Press the Back button to save the User Name and return to the System Settings screen.

### ► Contrast

To adjust the screen contrast:

1. Scroll to Contrast and press the scroll wheel.
2. Scroll left or right to adjust the contrast value. Lower numbers lighten the contrast, higher numbers darken it.
3. Press the scroll wheel once to save the selection.

### ► Backlight

The Backlight field adjusts the backlight appearance time and brightness. You have the option to turn the backlight off for models you fly during the day and turn the backlight on for night flying models.

The backlight time options are:

- Off:** Appears for a short time when you power on the transmitter.
- On:** The backlight is always on.

**Set Time:** The backlight is on for 3, 10, 20, 30, 45 or 60 seconds before automatically turning off. Press the scroll wheel once to turn the backlight on.

The backlight percentage adjusts the backlight intensity and it is adjustable in 10% increments from 10% (darker) to 100% (brighter).

### ► Mode

You can easily change the transmitter Modes from 1, 2, 3 and 4. Use the slider found on the back of the transmitter to change between modes (2, 4) and (1, 3).\*

Finish the mode change by following the programming steps below.

To change the gimbal stick mode:

1. Scroll to Mode and press the scroll wheel.
2. Scroll left or right to change the gimbal stick mode. Press the scroll wheel to save the selection.

3. Select NEXT in the lower left corner until the Calibration screen appears.
4. Move all transmitter controls to the center position and complete the calibration process before exiting the System Settings menu. See "Calibrating Your Transmitter" for more information.

\*For more information, see Physical Transmitter Adjustments in the back of the manual.

### ► Battery Alarm

Battery Alarm enables you to change the transmitter battery type and the alarm voltage limit. The alarm activates when the battery reaches the low voltage limit.

To change the battery alarm:

1. Scroll to the battery type and press the scroll wheel once to change the type to LiPo/Li-Ion or NiMH.
2. Scroll to the battery voltage and press the scroll wheel. Turn the scroll wheel left or right to change the voltage level. Press the scroll wheel again to save the selection.

 **CAUTION:** Never select NiMH when a LiPo/Li-Ion battery is installed in the transmitter. Doing so may over-discharge the LiPo battery and damage the battery, transmitter or both.

 **CAUTION:** Never adjust the low voltage limit for the LiPo/Li-Ion battery pack below 6.4V. Doing so could over-discharge the battery pack and damage both battery pack and transmitter.

## SYSTEM SETUP

### ▶ Selecting a Language

In the Systems Settings screen, scroll to highlight Language, then press the scroll wheel to select the Language function. Scroll to select the desired Language. When the desired Language is selected, press the scroll wheel to accept that Language. Names you input will not be affected by language change. After changing the language for the text, you may also want to change the language for the spoken alerts. See the “Spoken” and “SD Card” sections for more information.

### ▶ Inactive Alarm

An alarm activates if the transmitter sees a period of inactivity for a certain amount of time. The alarm is helpful in reminding you to power off the transmitter and avoiding a situation where the transmitter battery completely discharges.

The Inactive Alarm options are:

- Inh (No alarm sounds)
- 5 min
- 10 min (Default)
- 30 min
- 60 min

### ▶ ▶ Extra Settings

The Extra Settings screen enables you to:

- Turn sounds off or on
- Change the appearance of the trim indicators

### To change the Inactive alarm time:

1. Scroll to the current alarm time and press the scroll wheel.
2. Scroll left or right to change the alarm time. Press the scroll wheel to save the selection.

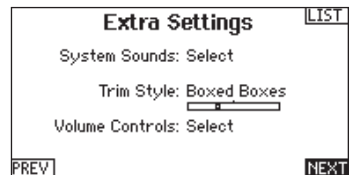

### System Sounds:

Scrolling to System Sounds and pressing the scroll wheel turns sounds on (Active) or off (Inhibit).

You may disable all sounds by changing the volume to 0.



### Trim Style:

Trim style changes the shape of the trim indicators on the Main Screen. Display options include:

- Boxed Boxes (Default)– The indicators appear as an outlined box when you adjust the trim.
- Boxed Arrows– The indicators appear as outlined arrows when you adjust the trim.
- Arrows on Lines– The indicators appear as arrows on lines when you adjust the trim.

Inhibit removes all trim bars and indicators from the Main Screen.

### To change the Trim style:

1. Scroll to Trim style and press the scroll wheel once.
2. Scroll left or right to change the Trim style option. Press the scroll wheel to save the selection.

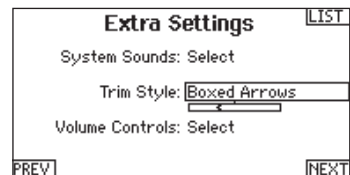

## SYSTEM SETUP

### ▶ ▶ Serial Number

The Serial Number screen displays the transmitter serial number and Spektrum AirWare software version.

Reference the Serial Number screen any time you need to register your transmitter or update the Spektrum AirWare software from the Spektrum Community website.

### ▶ ▶ Exporting the Serial Number to the SD Card

You may find it helpful to export the transmitter serial number to a text file for your personal records or when you are registering the transmitter on the Spektrum Community.

To export the transmitter serial number:

1. Insert an SD Card in the card slot on the transmitter.
2. Scroll to EXPORT and press the scroll wheel. The SD Status screen appears and should display MY\_DX8e.xml in the middle of the screen.
3. Press the scroll wheel again to return to the Serial Number screen.
4. Power off the transmitter and remove the SD Card from the transmitter.

5. Install the SD Card in a card reader connected to your computer.
6. Open the MY\_DX8e.xml file from the SD Card location. You can then copy and paste the serial number into your personal records or to the Spektrum Community website.

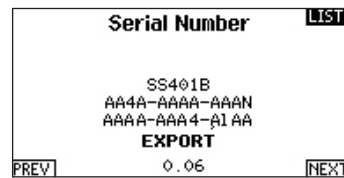

### ▶ ▶ Locating the Transmitter Spektrum AirWare Software Version

The transmitter Spektrum AirWare software version appears between PREVIOUS and NEXT at the bottom of the Serial Number screen. Register your DX8e to get Spektrum AirWare software updates and other news at [spektrumrc.com](http://spektrumrc.com)

**IMPORTANT:** Spektrum AirWare files are specific to the transmitter serial number and you cannot transfer Spektrum AirWare files between transmitters, i.e., downloading an Spektrum AirWare software update once and attempting to install it on multiple transmitters.

### ▶ ▶ Calibrate

The Calibration screen stores the potentiometer endpoints for all proportional controls. It is mandatory to complete the calibration after changing the stick mode selection.

#### Calibrating the Transmitter

1. Carefully move the gimbal sticks in a + shape moving from left to right, then up and down. Press gently on the gimbals at the stops to achieve an accurate calibration. Return both gimbal sticks to the center position.
2. Select SAVE to store the calibration.

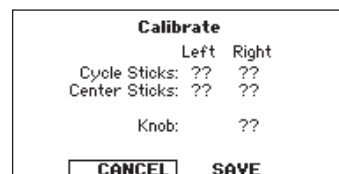



## SYSTEM SETUP

### Transfer SD Card

The SD Card enables you to:

- Import (copy) models from another DX8e transmitter
- Export (transfer) models to another DX8e transmitter
- Update Spektrum AirWare™ software in the transmitter
- Install/Update sound files

#### ► Import Model

This function overwrites all model memories. Ensure that the models currently in your transmitter are saved on an SD card separate from the transmitter before performing this function.

To import an individual model file from the SD Card:

1. Save the model file to the SD Card.
2. Select the Model List location where you wish to import the new model file.
3. In the SD Card menu, scroll to Select Option and press the scroll wheel once.
4. Scroll to Import Model and press the scroll button again to save the selection. The Select File screen appears.

**IMPORTANT:** When you select Import, the transmitter leaves the System Setup List.

5. Select the model file you wish to import. The Overwrite screen appears.
6. Select the model that you would like to import the model to.
7. Select Import to confirm overwriting the current model file. The transmitter activates the new model file and the Main Screen appears.

A Preflight Checklist may appear prior to the Main Screen if the checklist was active during the model file export. Select MAIN to exit the Preflight Checklist.

See “*Preflight Setup*” for more information.

#### ► Export Model

You can use the Export Model option to export a single model file to the SD Card.

1. Make sure the active model file is the one you wish to Export.
2. In the Transfer SD Card menu, scroll to **Options** and press the scroll wheel once.
3. Scroll to Export Model and press the scroll wheel again to save the selection. The Export to SD screen appears. The first two characters of the file name correspond to the Model List number (01, for example).
4. (Optional) If you wish to rename the model file before exporting it to the SD Card:
  - a. Scroll to “Save to:” and press the scroll wheel. The File Name screen appears.
  - b. Assign a new file name. The file name can contain up to 25 characters including the .SPM file extension.
  - c. When you are done assigning the new file name, press the Back button to return to the Export to SD screen.
5. Select Export to save the file to the SD Card. When the export is complete, the transmitter returns to the SD Card Menu screen.

#### Import All Models

To import all models from the SD Card:

1. Select Import All Models.
2. Confirm by selecting IMPORT.

**IMPORTANT:** After importing a model, you must rebind the transmitter and receiver. The Main Screen must show DSM2 or DSMX in the upper left corner.

You can import a model to any location you want. If you prefer to use Import All, you can use your PC to rename the SPM file. The first two digits (01 to 50) are the destination model number. Your SD card can only contain 50 models. Save files to folders on the card then remove from the card all unused models. Files are selected by their position in the directory table.



#### Export All Models

To export all models to the SD Card:

1. Select Export All Models in the Transfer SD Card Menu options. The Export All Models screen appears.

**IMPORTANT:** Export All Models will overwrite any model files that:

- are already saved to the SD Card
- have the same name. Always save model files to a different SD card if you are not sure.

2. Select Export to overwrite files on the SD Card or Cancel to return to the SD Card Menu.



## SYSTEM SETUP

### ► Update AirWare Software

**NOTICE:** The orange LED Spektrum bars flash and a status bar appears on the screen when AirWare software updates are installing. Never power off the transmitter when updates are installing. Doing so may damage the system files.

Before installing any AirWare files, always Export All Models to an SD Card separate from the SD Card containing the update. The update may erase all model files.

For more information on AirWare software updates, visit [spektrumrc.com](http://spektrumrc.com)

#### Automatically Installing AirWare Software Updates

To install the most recent update:

1. Download the update from [spektrumrc.com](http://spektrumrc.com) and save it to the SD Card.
2. Power off the transmitter and install the SD Card in the transmitter.
3. Power on the transmitter and the update automatically installs in the transmitter.

#### Manually Installing AirWare Software Updates

1. Save the desired AirWare version to the SD Card.
2. Select Update Firmware in the SD Card Menu options. The Select File screen appears.
3. Select the desired AirWare version from the File List. When updates are installing, the transmitter screen is dark. The orange LED Spektrum bars flash and the update status bar appears on the screen.

**NOTICE:** Do not power off the transmitter when updates are installing. Doing so will damage the transmitter.

## FUNCTION LIST

The Main Screen appears when you power on the transmitter. Press the scroll wheel once to display the Function List.

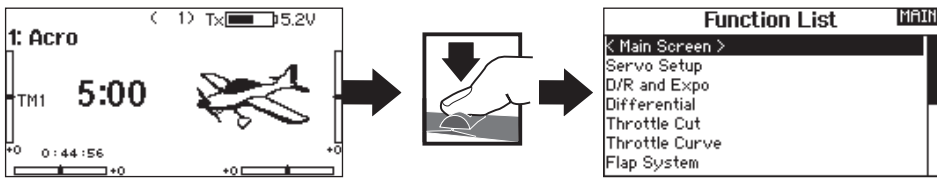

### Servo Setup

The Servo Setup menu contains the following functions:

- Travel Adjust
- Sub-Trim
- Reverse
- Speed
- Balance

#### ▶ Travel Adjust

Travel Adjust sets the overall travel or endpoints of the servo arm movement.

To adjust travel values:

1. Scroll to the channel you wish to adjust and press the scroll wheel. When adjusting travel values assigned to a control stick:
  - a. Center the control stick to adjust both directions at the same time.
  - b. To adjust travel in one direction only, move the control stick in the direction you wish to adjust. Continue holding the control stick in the desired direction while you are adjusting the travel value.
2. Scroll left or right to adjust the travel value. Press the scroll wheel to save the selection.

**IMPORTANT:** ALT, ROL, PIT and YAW replaces THR, AIL, ELE and RUD channels in multirotor to more closely reflect the flight axis in the multirotor aircraft. This change is throughout the multirotor menu options.

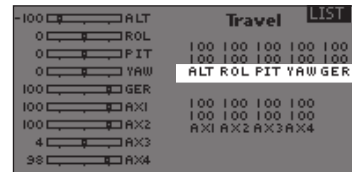
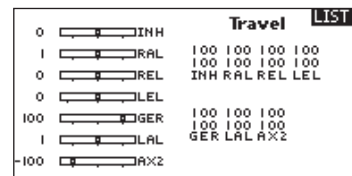

#### ▶ Sub-Trim

Sub-Trim adjusts the servo travel center point.

**NOTICE:** Use only small sub-trim values or you may cause damage to the servo.

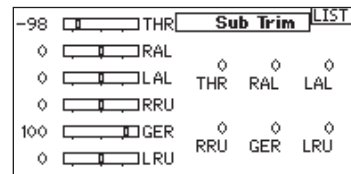

#### ▶ Reverse

Use the Reverse menu to reverse the channel direction. For example, if the elevator servo moves up and it should move down.

To reverse a channel direction:

1. Scroll to Travel and press the scroll wheel. Scroll left until Reverse appears and press the scroll wheel again to save the selection.
2. Scroll to the channel you wish to reverse and press the scroll wheel.

If you reverse the Throttle channel, a confirmation screen appears. Select YES to reverse the channel. A second screen appears, reminding you to bind your transmitter and receiver.

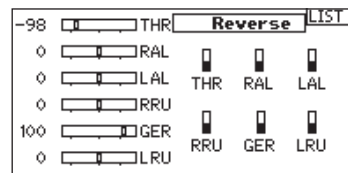

**CAUTION:** Always rebind the transmitter and receiver after reversing the Throttle channel. Failure to do so will result in the throttle moving to full throttle if failsafe activates.

Always perform a control test after making adjustments to confirm the model responds properly.

**CAUTION:** After adjusting servos, always rebind the transmitter and receiver to set the failsafe position.

## FUNCTION LIST

### ► Speed

The Speed menu enables you to slow the response time on any individual channel (such as retracts).

The Speed is adjustable in the following ranges:

- Nor (No Delay) – 0.9s in 0.1 second increments
- 1s – 2s in 0.2-second increments
- 2s – 8s in 1-second increments

To adjust the Speed:

1. Scroll to the channel you wish to adjust and press the scroll wheel.
2. Scroll left or right to adjust the speed and press the scroll wheel to save the selection.

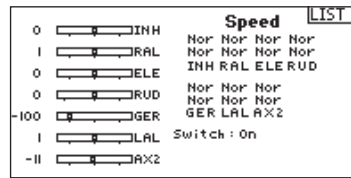

### ► Balance

Balance is available on all channels to fine-tune the servo position at up to 7 points. This is a precision curve mix that is normally used to prevent binding when multiple servos are used on a single control surface.

You can also use the Balance menu option to match throttle response on twin engine aircraft or level the swashplate on a helicopter.

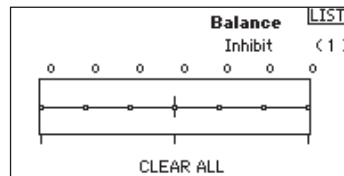

### ► AS3X Gain Live View (ACRO and SAIL Types Only)

When using a compatible AS3X receiver (AR636, AR6335, AR9350, etc.), Gain Live View allows

- Real time display of gain values for Roll Pitch and Yaw
- Allows gains to be adjusted from the roller
- Selection of the channel that is used to adjust gains (must match application)
- Selection of the switch that is used to change flight modes

To activate AS3X Gain Live View:

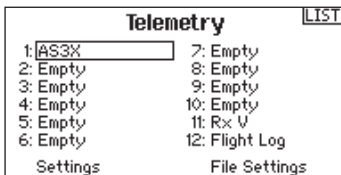

1. In the telemetry screen in one of the empty positions select AS3X and activate the Display. This will activate the AS3X Gain menu in the Function List.

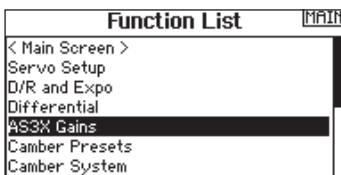

2. In the Function List Access the AS3X Gain menu. If an AS3X receiver is bound to the transmitter and the receiver and transmitter are on, live gain values will be displayed on this screen.

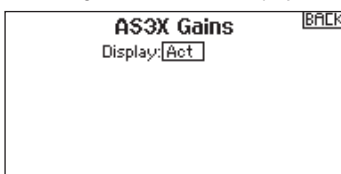

**Axis:** Roll Pitch and Yaw gain are displayed to the right of each Axis

**Rate:** Rate gain values are displayed here

**Heading:** Heading gain values are displayed here

**Actual:** The current gain value is displayed here. Note that this value takes into account the priority gain and the stick position of that channel

**Gain:** This value represents the position of the input (roller or knob)

**Input:** Allows the selection of the roller to be used to adjust the gain

**Channel:** Must correspond to the channel selected in the AS3X application in the FM Channel Assignment screen

**FM Switch:** Selects the switch on the transmitter that is used to select the flight modes in the AS3X system

Note that relative (REL) must be selected in the application's gain screen to allow adjustable gain from the transmitter.

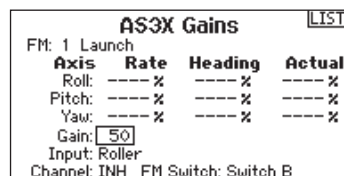

Please see the following web address for videos and information about setting up the AS3X application, Live View and adjusting the gain from the transmitter.

<http://www.spektrumrc.com/Technology/AS3X.aspx>

## FUNCTION LIST

### ► D/R & Exponential

Dual Rates and Exponential are available on the aileron, elevator and rudder channels.

To adjust the Dual Rate and Exponential:

1. Scroll to the channel and press the scroll wheel once. Scroll left or right to select the channel you wish to change and press the scroll wheel again to save the selection.
2. Scroll to Switch and select the switch to activate D/R and Expo for that channel.
3. Scroll to dual rate and press the scroll wheel. Scroll left or right to change the value and press the scroll wheel again to save the selection.

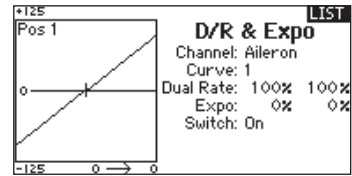

Exponential affects control response sensitivity around center but has no effect on overall travel. Positive exponential decreases the sensitivity around the center of gimbal movement.

### ► Differential (ACRO and SAIL Types Only)

The Differential screen enables you to increase or decrease the amount of differential between aileron control surface throws.

*Positive* Differential values decrease the amount of “down” travel without affecting the “up” travel on the opposite control surface.

*Negative* Differential values decrease the amount of “up” travel without affecting the amount of “down” travel on the opposite control surface.

The Differential menu option only appears when a multi-servo aileron wing type is active in Aircraft Type.

To adjust the Differential:

1. Scroll to Switch and press the scroll wheel. Scroll right to select On (Differential is always on) or assign the differential to a switch position.

2. Press the scroll wheel a second time to save the selection.
3. Scroll to the percentage selection and press the scroll wheel once to change the value.
4. Press the scroll wheel again to save the selection.

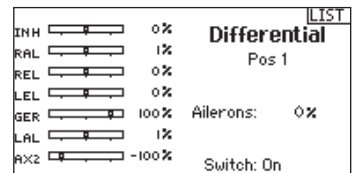

### ► Throttle Cut (ACRO and HELI Types Only)

The Throttle Cut menu option enables you to assign a switch position to stop an engine or motor. Throttle Cut activates regardless of Flight Mode.

When you activate Throttle Cut, the throttle channel moves to the pre-programmed position (normally Off).

You may need to use a negative value to move the Throttle channel to the off position.



**CAUTION:** Always test the model after making adjustments to make sure the model responds to controls as desired.

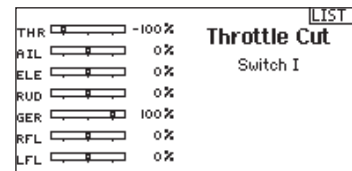

### ► Throttle Curve (ACRO and HELI Types Only)

You can use the Throttle Curve menu option to optimize the throttle response. A maximum of 7 points are available on the throttle curve.

To add points to a Throttle Curve:

1. Move the throttle stick to the position where you wish to add the new point.
2. Scroll to Add Pt. and press the scroll wheel to add the point.

To remove points from a Throttle Curve:

1. Move the Throttle stick until the cursor is near the point you wish to remove.
2. Scroll to Remove Pt. and press the scroll wheel once to remove the point.

If you program multiple throttle curves and you wish to edit one of the curves, that curve must be active in the Throttle Curve screen before you can make any changes.

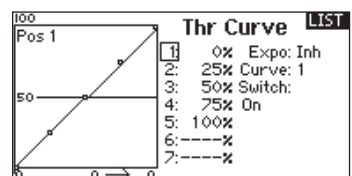

## FUNCTION LIST

The following menu options are only available when they are enabled from the Model Type screen.

- V-Tail Differential** ▶ Only available in Sailplane Type when V-Tail A or V-Tail B is active. See **SAIL** (Sailplane) section for set up.
- Camber Preset** ▶ Only available in Sailplane Type when a 2+ aileron wing type is selected. See **SAIL** (Sailplane) section for set up.
- Camber System** ▶ Only available in Sailplane Type when a 2+ aileron wing type is selected. See **SAIL** (Sailplane) section for set up.
- Flap System** ▶ Only available in Airplane Type when a flap-enabled wing type is selected. See **ACRO** (Airplane) section for set up.
- Pitch Curve** ▶ Only available in Helicopter Type. See **HELI** (Helicopter) section for set up.
- Swashplate** ▶ Only available in Helicopter Type. See **HELI** (Helicopter) section for set up.
- Gyro** ▶ Only available in Helicopter Type. See **HELI** (Helicopter) section for set up.
- Tail Curve** ▶ Only available in Helicopter Type. See **HELI** (Helicopter) section for set up.
- Motor Cut** ▶ Only available in Multicopter Type. See **MULTI** (Multicopter) section for set up.
- Motor Curve** ▶ Only available in Multicopter Type. See **MULTI** (Multicopter) section for set up.

## Mixing

Mixing allows control input for a channel to affect more than one channel at a time. Mixing functions support:

- Mixing a channel to another channel.
- Mixing a channel to itself.
- Assigning offset to a channel.
- Linking primary to secondary trim.

These mixes are available for each model memory:

- 8 programmable mixes
- Cyclic to Throttle (HELI)
- Swashplate (HELI)
- Elevator to Flap (ACRO)
- Aileron to Rudder (ACRO)
- Rudder to Aileron/Elevator (ACRO)
- Aileron>Rudder (SAIL)
- Aileron>Flap (SAIL)
- Elevator>Flap (SAIL)
- Flap>Elevator (SAIL)

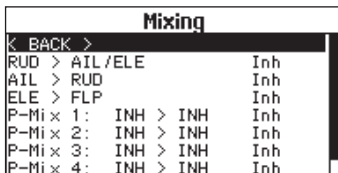

Select a channel for master and slave. Inputs for the master channel control both the master and slave channels. For example, Elevator to Flap makes elevator the master channel and flap the slave channel.

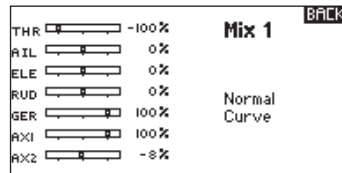

### Offset

Change the Offset value to move the effective center position of the slave channel. Positive or negative value determines the direction of the offset. Offset is not available for curve mixes.

### Trim

If the master channel trim should also adjust the slave channel, set Trim to Act. A channel monitor on the left side of the screen shows how channels respond to input. To view a switch-assigned mix on the monitor, the mix switch must be in the active position.

## Assigning a Mix to a Switch

If you wish to assign a mix to a switch position:

1. Make sure you are in the desired mix screen.
2. Move the switch you want to assign the mix to.
3. Scroll to the switch position where you want the mix to be active.
4. Press the scroll wheel to activate the mix. When the box is filled, the mix is active.

The mix is Active when the box is filled and Inactive when the box is open. You can assign a mix to be active in multiple switch positions (0,1 or 2).

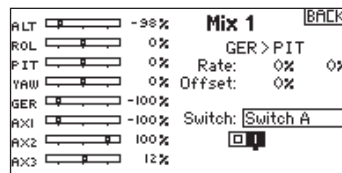

**Tip:** Use Auto Switch Select to select the switch.



**CAUTION:** Always do a Control Test of your model after changing mixes.



## FUNCTION LIST

### Back Mixing

Back Mixing applies to all related servos in a multi servo Aileron/ Flapped wing or a multi servo split elevator. Creating a mix to RAL (Right Aileron) or LAL (Left Aileron) will create different results and enables you to use fewer mixes to achieve the desired response.

**Example 1:** Creating a mix AIL > RAL will move the ailerons in opposite directions, while creating a mix AIL > LAL will move the ailerons in the same direction.

**Example 2:** Create a mix ELE > REL will move the elevator halves together, while mixing ELE > LEL will move the elevator halves in the opposite direction (tailerons).

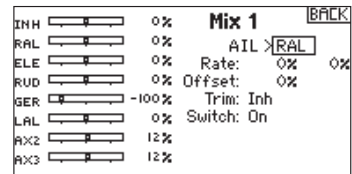

**IMPORTANT:** Be sure the right aileron is connected into the AIL port on the receiver and the left Aileron is connected into the Aux1 port on the receiver.

### Range Test

The Range Test function reduces the power output. This allows for a range test to confirm the RF link is operating correctly. Perform a range check at the beginning of each flying session to confirm system operation.

To Access the Range Test screen:

1. With the transmitter on and the main or telemetry screen displayed, press the scroll wheel. The Function list displays.
2. Scroll to highlight Range Test, then press the scroll wheel to access the Range Test function.
3. With the Range Test screen displayed, push and hold the trainer button. The screen displays Reduced Power. In this mode the RF output is reduced allowing for an operational range test of your system.
4. If you let go of the trainer button, the transmitter will go back to Full Power.

**IMPORTANT:** Telemetry alarms are disabled during the Range Test.

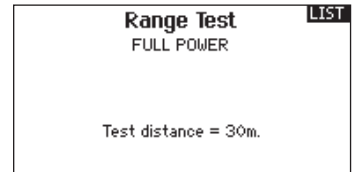

### Range Testing the DX8e

1. With the model restrained on the ground, stand 30 paces (approx. 90 feet/28 meters) away from the model.
2. Face the model with the transmitter in your normal flying position and place the transmitter into Range Test mode (see above). Then push the trainer button; the power output will be reduced.
3. Operate the controls. You should have total control of your model with the transmitter in Range Test mode.
4. If control issues occur, contact the appropriate Horizon Product Support office for assistance.
5. If performing a range test while a telemetry module is active, the display will show flight log data.

### Timer

The DX8e Timer function allows you to program a countdown timer or stop watch (count up timer) to display on the main screen. An alarm sounds when the programmed time is reached. You can program the timer to start using the assigned switch position or automatically when throttle is raised above a programmed position. Two internal timers are available that show run time for a specific model displays on the Main Screen. A total system timer is also available.

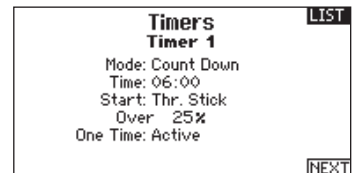

## FUNCTION LIST

### ► Timer Event and Timer Control Alerts

Press NEXT to select the Timer Event Alerts settings. These include options for the alerts at every minute for down timers, 1 minute remaining alert, 30 seconds remaining alert, 10 second to 1 second remaining alerts, expiration alert, and every minute up alert. Press NEXT again to select the Timer Control Alerts settings. Available options include Timer Start alert, Timer Stop alert, and Timer Reset alert.

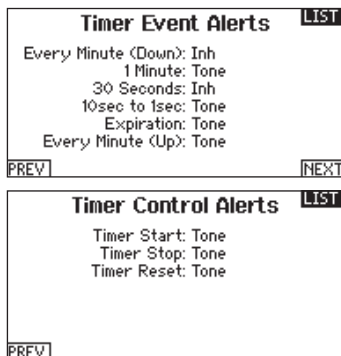

### Telemetry

Telemetry is in both the system setup and the function list so you can access the telemetry functions from either list.

You must power off the receiver and transmitter, then power them both on to reset the telemetry data. You can reset min/max values by pressing the CLEAR button.

NEVER change Telemetry settings when the aircraft is powered on. There is a brief interruption in RF output when exiting the Telemetry screen, and may cause a "Hold" condition.

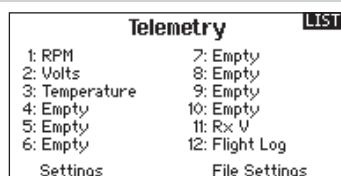

### System Setup

Use System Setup to enter the System List from the Function list without turning the transmitter off. A Caution screen will appear that warns that RF will be disabled (the transmitter will no longer transmit). Press YES if you are sure and want to access the System List. If you are not sure, press NO to exit to the main screen and continue operation.

If you do not press YES or NO, the system will exit to the main screen and continue operation within approximately 10 seconds.

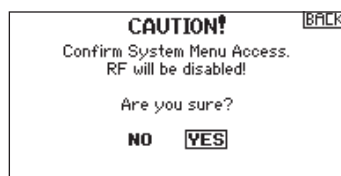

**WARNING:** Do not press YES unless the model is turned off or the model is secured.

### Monitor

The Monitor screen displays the servo positions for each channel graphically and numerically. This is useful to verify programming functions, trim settings, mix directions, etc. The numeric value is directly relative to the travel adjust and mix values (e.g. 100% travel adjust equals 100% value in the Monitor).

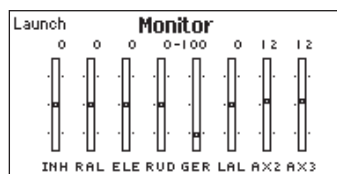

## ACRO (AIRPLANE)



### Acro Model Type

**NOTICE:** Refer to your airplane manual for recommended control throws.



**CAUTION:** Always do a Control Test of your model with the transmitter after programming to make sure your model responds as desired.

### Aircraft Type

Use the Aircraft Type Screen to select wing and tail types to match your airplane model. Diagrams and setup names show on the transmitter screen to show the available setups.

Refer to [spektrumrc.com](http://spektrumrc.com) for more information about new DX8e AirWare software updates to support these options.

**Select wing and tail types before doing any other programming.**

#### Wing

- Normal
- Flaperon\*
- Dual Aileron\*
- 1 Aileron 1 Flap\*
- 1 Aileron 2 Flap\*
- 2 Ailerons 1 Flap\*
- 2 Ailerons 2 Flap\*
- Dual Rudder/Elevator
- Elevon A\*
- Elevon B\*

#### Tail

- Normal
- V-Tail A\*\*
- V-Tail B\*\*
- Dual Elevator
- Dual Rudder

\*Selection of multiple ailerons activates the Differential menu option.

\*\*"V-Tail A" and "V-Tail B" function as internal servo reversing. If V-Tail A does not work correctly with your aircraft, try V-Tail B.

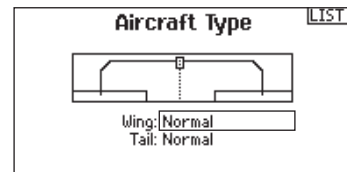

### Recommended Servo Connections

#### Dual Aileron Wing Type Connection

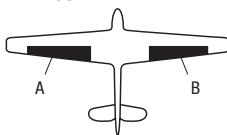

#### Elevon Wing Type Connection

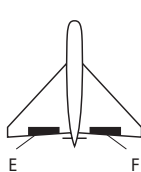

#### V-Tail Type Connection

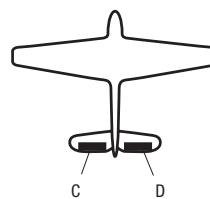

- A** AUX1 servo port (left aileron)
- B** AILE servo port (right aileron)
- C** ELEV servo port (left V-tail)
- D** RUDD servo port (right V-tail)
- E** AILE servo port (left aileron)
- F** ELEV servo port (right aileron)

### Icon

To change the Aircraft Icon:

1. In the Aircraft Type Screen, select NEXT at the bottom right of the screen. This will access the Aircraft Options screen.
2. Scroll to the image and click once. Roll the scroll wheel left or right for optional images.
3. Click on the image you wish to select.



## ACRO (AIRPLANE)

### Elevon Servo Control

The possible servo reversing options for a delta wing model are:

Aileron	Elevator
Normal	Reverse
Normal	Normal
Reverse	Reverse
Reverse	Normal

**Tip:** If you test all servo reversing options and the control surfaces do not move in the correct direction, change the Elevon wing type in the System Setup list from Elevon A to Elevon B.

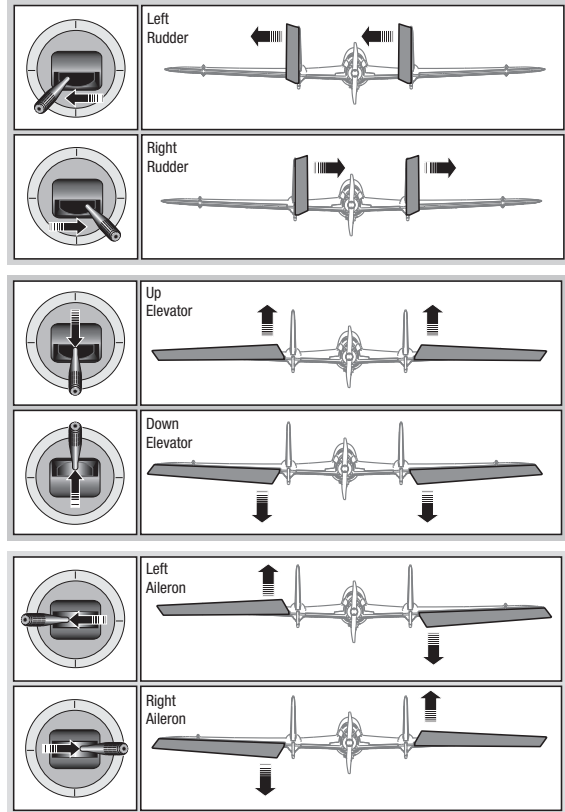

### Flap System

The Flap System menu option enables flap programming as well as elevator mixing. You must select a flap-enabled wing type in Aircraft Type or the Flap System menu does not appear.

To activate the Flap System:

1. Access the System Setup list and select Aircraft Type.
2. Select a flap-enabled wing type and exit the System Setup list.
3. Access the Function List from the Main Screen and select Flap System.
4. Select Inhibit and scroll to the switch or lever you wish to use to control the flap channel.

5. Assign the Flap travel values and any desired Elevator mixing.
6. Select a Flap speed, if desired. Norm (default) does not have a delay. Flap speed options range from 0.1s to 30 seconds.

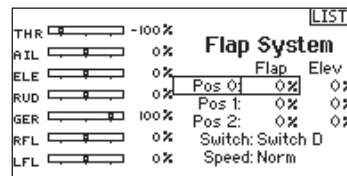

### ACRO Mixing

#### Rudder to Aileron/Elevator

Rudder to Aileron/Elevator mixing corrects coupling in knife edge flight.

- Add Elevator mixing if the aircraft pitches toward the landing gear or canopy
- Add Aileron mixing if the aircraft rolls in knife edge flight

#### Aileron to Rudder

Use Aileron to Rudder mixing to overcome adverse yaw characteristics with certain types of aircraft (such as high-wing aircraft).

#### Elevator to Flap

Elevator to Flap mixing enables Flap movement when the Elevator stick moves. Use Elevator to Flap mixing to add the spoileron function to 3D aerobatic aircraft. This mix is available when a flap or dual aileron wing type is selected.

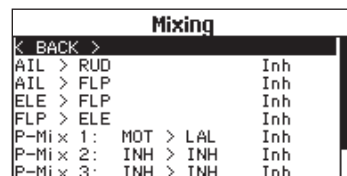

## HELI (HELICOPTER)



### Heli Model Type

**NOTICE:** Refer to your helicopter, gyro and governor manuals for programming recommendations.

**CAUTION:** Always do a Control Test of your model with the transmitter after programming changes to make sure your model responds as desired.

#### To change the Helicopter Icon:

From the Collective Type Screen, select NEXT at the bottom right of the screen. This will access the Heli image screen. Scroll to the icon and click once. Roll the scroll wheel left or right for optional icons.



### Swash Type

The Swash Type menu option assigns the swash type for your particular helicopter model.

Select the Swash Type before completing any programming in the Function List. The Swash Type will affect menu options in the Function List.

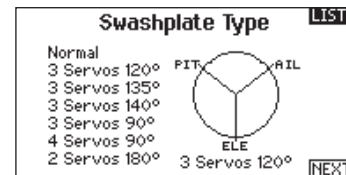

### Collective Type

The collective type is used to turn on "Pull" collective for reversed collective. Available settings are Normal and Reverse. Press NEXT from the Swashplate Type screen to access the Collective Type screen. The Collective Type allows the throttle/pitch stick to operate in reverse and ensures trims, curves and all other functions that are to work in reverse function properly.

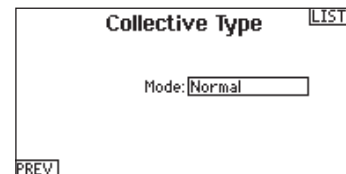

### Pitch Curve

This function supports adjustment of collective pitch in 5 flight modes.

#### To adjust the Pitch Curve:

1. Select the Pitch Curve you wish to edit (N, 1 or 2).
2. Scroll right to select the points on the curve and edit the respective values.
3. Press the BACK button to save the Pitch Curves and return to the Function List.

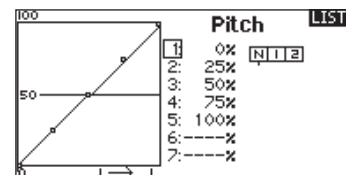

# HELI (HELICOPTER)

## Swashplate

The Swashplate menu option enables you to adjust the following:

- Swashplate Mix
- Exponential
- E-Ring
- Elevator Compensation

Use positive or negative Swashplate mix values as needed for correct direction response of the helicopter.

Before making adjustments to the Swashplate mix, make sure the throttle/collective pitch input moves the entire swashplate up or down. If the servos are not moving in the same direction, reverse them as necessary in the Servo Setup menu option.

**When the entire swashplate moves up or down:**

1. Adjust the mix value for the Aileron and Elevator channels. If the servos do not move in the correct direction, change the direction of the mix—for example, a positive value instead of a negative value.
2. Adjust the mix value for the Pitch. If the swashplate does not move in the correct direction, change the direction of the value (negative instead of positive).

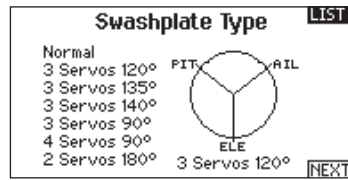

Always enable Expo when using a standard rotating-arm servo.

The Expo delivers linear movement of the swashplate from a standard rotary servo. When Expo is inhibited, the arm on a rotary servo moves on a curved path with decreased swashplate movement at the extremes of the servo arm travel.

**NOTICE:** Do not enable Expo when using a linear servo.

### Electronic E-Ring

This feature prevents over driving servos by limiting servo travel if the sum of your cyclic and pitch inputs exceeds servo limits.

## Gyro

The Gyro menu option enables you to assign a gyro gain value to an independent switch or a Flight Mode. Assign the receiver channel connected to the gyro, then assign the switch for gyro options. You can also assign values to available switch positions (from 1 to 4 rates are available, depending on the switch assigned). Make sure the gyro operates correctly and compensates in the correct direction.

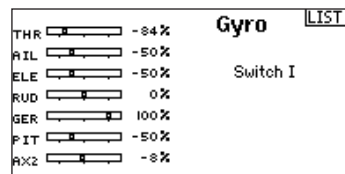

## Tail Curve

The Tail Curve function mixes tail rotor input with the throttle/collective function to counter torque from the main rotor blades when using a non-heading hold (tail lock) gyro or when using rate mode on a gyro. See Pitch Curve for more information on programming curves.

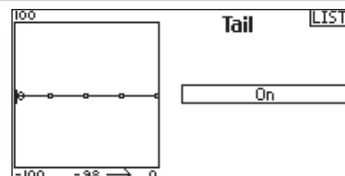

## Mixing

### Cyclic to Throttle

Cyclic to Throttle mix prevents rpm loss when aileron, elevator or rudder inputs are given. This mix advances the throttle position with cyclic or rudder control to maintain rpm. At full throttle, Cyclic to Throttle mixing prevents the throttle from over driving the servo.

**IMPORTANT:** Do not use Cyclic to Throttle mix when using a governor.

To verify that the Cyclic to Throttle mix is working properly and in the correct direction, move the flight mode switch to one of the active positions. Move the programmed cyclic or rudder channel, noting the throttle position. The throttle position should increase.

If the throttle decreases, then the opposite value (positive vs. negative) is needed.

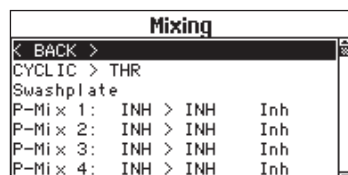

### Swashplate

The Swashplate Mix typically corrects swashplate timing issues by mixing Aileron to Elevator and Elevator to Aileron. When adjusted correctly, the Swashplate causes the helicopter to roll and pitch accurately with minimal interaction.



# SAIL (SAILPLANE)



## Sailplane Model Type

**NOTICE:** Refer to your sailplane manual for recommended control throws.

**CAUTION:** Always do a Control Test of your model with the transmitter after programming to make sure your model responds as desired.

## Sailplane Type

Use the Sailplane Type Screen to select wing and tail types to match your sailplane model. Diagrams and setup names show on the transmitter screen to show the available setups.

Refer to [spektrumrc.com](http://spektrumrc.com) for more information about new DX8e Spektrum AirWare updates to support these options.

Wing	Tail	Motor
1 Servo	Normal	Inhibit
2 Aileron*	V-Tail A**	Assign to a Switch (optional)
2 Aileron 1 Flap*	V-Tail B**	
2 Aileron 2 Flap*		

\*Selection of multiple ailerons activates the Differential menu option.

\*\*V-Tail A\* and V-Tail B\* function as internal servo reversing. If V-Tail A does not work correctly with your aircraft, try V-Tail B.

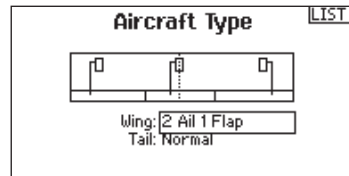

## Sailplane Icon

In the Sailplane Type screen, select NEXT at the bottom right of the screen. This will access the Sailplane Image screen. Click once on the image and roll the scroll wheel left or right to for optional images.



## Camber Preset

Camber Preset is only available when 2 aileron wing type is selected in Sailplane Type. The Camber Preset function enables you to program the ailerons, flaps, wing tips and elevator for a specific position in each Flight Mode.

If flight modes are not active, only one preset position is available and it is always active.

The Camber Preset Speed enables the control surfaces to transition over a period of time, up to 30 seconds, when you change flight modes.

Move the flight mode switch to the desired position to change the Camber Preset values.

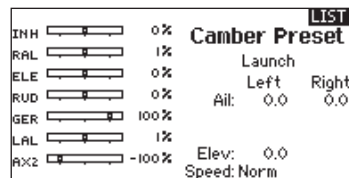

## Camber System

Camber System is only available when 2 aileron wing type is selected in Sailplane Type. The Camber System allows in-flight camber adjustment and is also used as the braking system, often referred to as Crow or Butterfly. The Camber System enables you to assign the Camber System to a different switch in each flight mode.

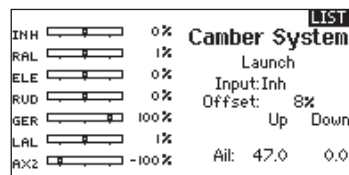

## SAIL (SAILPLANE)

### SAIL Mixing

For each of these mixes, you can program each flight mode with different mix values or at 0% if no mix is desired for that specific flight mode. Programming values include independent control of the direction and amount a slave surface moves in relationship to the master surface.

#### Aileron to Rudder

The Aileron to Rudder mix is commonly used for coordinated turns. When active, as aileron is applied the rudder moves in the same direction as the turn (right aileron input results in right rudder output). If you assign the flight mode to a switch, a Sub Switch option allows you to assign an additional switch to activate up to 3 Aileron to Rudder mixes for that flight mode.

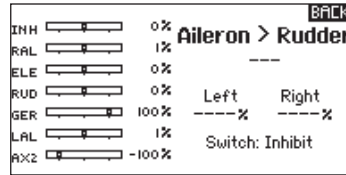

#### Aileron to Flap

The Aileron to Flap mix allows the entire trailing edge of the wing (aileron and flap) to operate as ailerons. When active, as aileron is applied the flaps also move. Always program the flaps to move in the same direction as the turn (so that right aileron is equivalent to flaps moving as right ailerons).

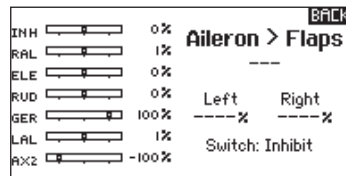

#### Elevator to Flap

Elevator to Flap mix creates additional lift, allowing a tighter turn. The entire trailing edge of the wing (aileron and flap) operates as flaps (camber increase) when you apply elevator. An offset is provided, which is typically used for Snap Flaps. With Snap Flap, no Elevator to Flap mix occurs until the offset value is reached. Typically, this offset is at 70% up elevator so that beyond 70% the down flap mix comes in, providing additional lift for more aggressive turning (for tight thermals or racing turns).

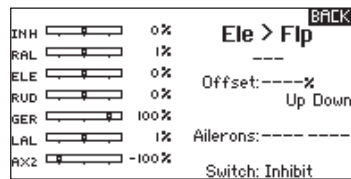

#### Flap to Elevator

Flap to Elevator mix prevents pitch up tendency that occurs when you apply Crow or Butterfly. This mix is typically used only with the Camber System. The Flap to Elevator mix operates as a curve so that the elevator moves down the most during the first 20% of flap deployment, decreases over the next 40%, then remains the same from 60 to 100% of flap travel.

For sailplanes with ailerons/tips/flaps, make sure an appropriate Sailplane Type is selected so that tips appear in the transmitter as RAIL and LAIL. Decrease or increase travel on the tip ailerons by creating an AIL > RAIL mix.

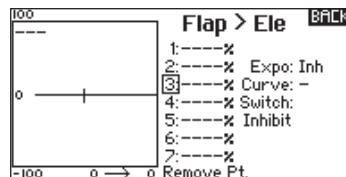

### V-Tail Differential

The V-Tail Differential screen enables you to increase or decrease the amount of differential between control surface throws.

*Positive* Differential values decrease the amount of “down” travel without affecting the “up” travel on the opposite control surface.

*Negative* Differential values decrease the amount of “up” travel without affecting the amount of “down” travel on the opposite control surface.

The V-Tail Differential menu option only appears when V-Tail A or V-Tail B is active in Aircraft Type.

#### To adjust the V-Tail Differential:

1. Scroll to Switch and press the scroll wheel. Scroll right to select On (Differential is always on) or assign the differential to a switch position.
2. Press the scroll wheel a second time to save the selection.
3. Scroll to Diff: and press the scroll wheel once to change the value.
4. Press the scroll wheel again to save the selection.

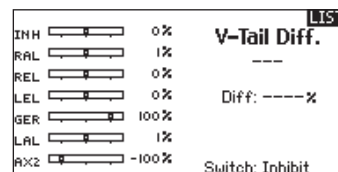

## MULTI (MULTIROTOR)



### Multicopter Model Type

**NOTICE:** Refer to your multicopter manual for programming recommendations.



**CAUTION:** Always do a Control Test of your model with the transmitter after programming to make sure your model responds as desired.

The Aircraft Options menu allows you to select a camera gimbal axis. Select None, 1–Axis, 2–Axis or 3–Axis from the Camera Options box.

The model icon can be changed by selecting the icon and scrolling left or right to select.



### Multicopter Image

In the Aircraft Options screen, roll to the image. Click once on the image and roll the roller left or right for optional images.

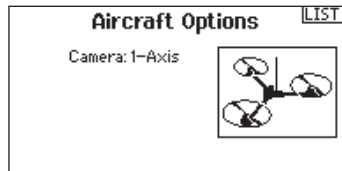

## F-Mode Setup

By default switch B is assigned 3 Flight Modes. You can assign up to five flight modes using any combination of up to two switches.

### Channel Assign

Scroll and Select Channel to assign channel inputs and outputs for each Flight Mode. Each channel can be assigned any switch on the transmitter including but not limited to trim switches, gimbals and the Clear/Back buttons.

**Example:** Assign Flight Mode 1 to be your primary flight mode where your gimbals control primary flight axis. Switching to Flight Mode 2, you can have the gimbals control the camera axis and the trim buttons control primary flight axis.

**Tip:** You can also access the Channel Assign from the Channel Assign Menu in System Setup.

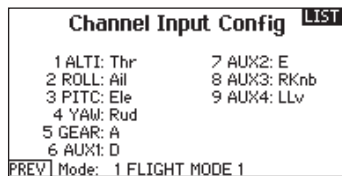
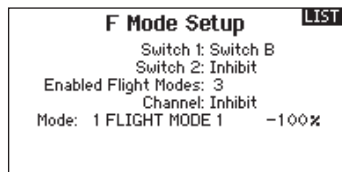

## Trim Setup

By default Trims are setup for **F Mode**.

**F Mode** trim type enables you to save trim values for individual flight modes if you find, for example, the aircraft requires Roll trim in Flight Mode 1 but not in Flight Mode 2.

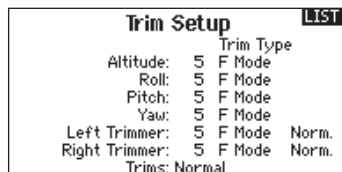

## MULTI (MULTIROTOR)

### D/R and Exponential

Dual Rates and Exponential are available on the PIT, ROL and YAW channels.

To adjust the Dual Rate and Exponential:

1. Scroll to the channel and press the scroll wheel once. Scroll left or right to select the channel you wish to change and press the scroll wheel again to save the selection.
2. Scroll to Switch and press the scroll wheel to select. Move the switch you want to assign to D/R.
3. Scroll to dual rate and press the scroll wheel. Scroll left or right to change the value and press the scroll wheel again to save the selection.

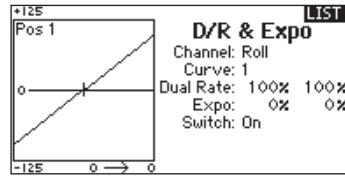

Exponential affects control response sensitivity around center but has no affect on overall travel. Positive exponential decreases the sensitivity around the center of gimbal movement.

### Motor Cut

The Motor Cut menu option enables you to assign a switch position to stop the motor. Motor Cut activates regardless of Flight Mode.

When you activate Motor Cut, the ALT channel moves to the pre-programmed position (normally Off).

You may need to use a negative value to move the ALT channel to the off position.

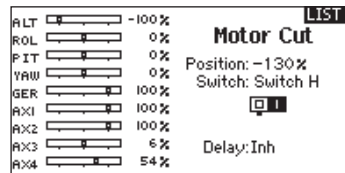

**CAUTION:** Always test the model after making adjustments to make sure the model responds to controls as desired.

### Motor Curve

You can use the Motor Curve menu option to optimize the throttle response. A maximum of 7 points are available on the throttle curve.

To add points to a Motor Curve:

1. Move the throttle stick to the position where you wish to add the new point.
2. Scroll to Add Pt. and press the scroll wheel to add the point.

To remove points from a Motor Curve:

1. Move the motor stick until the cursor is near the point you wish to remove.
2. Scroll to Remove Pt. and press the scroll wheel once to remove the point.

If you program multiple throttle curves and you wish to edit one of the curves, that curve must be active in the Motor Curve screen before you can make any changes.

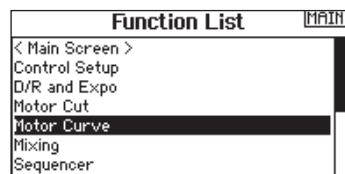

## PHYSICAL TRANSMITTER ADJUSTMENTS

The DX8e has all the physical transmitter adjustments located around the gimbal face of each gimbal. This arrangement allows for quick and easy adjustments without taking the back cover off or removing any plugs to access adjustment screws.

### Available adjustments:

- Change the Throttle Ratchet*
- Change the Throttle Tension*
- Adjust Stick Tension*

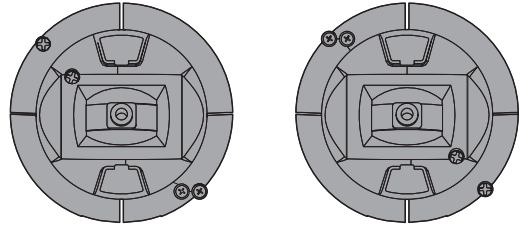

### Ratcheted Throttle – Smooth Throttle Adjustment

#### Ratchet:

1. Locate the throttle strap adjustment screws on both gimbals. The ratchet set screw engages a serrated section on the gimbal for a ratcheted throttle, while the tension set screw engages a strap for smooth tension on the gimbal.
2. To engage the throttle ratchet turn the ratchet set screw clockwise until the ratchet engages.
3. To disengage the throttle ratchet turn the screw counter clockwise until the gimbal moves freely.

#### Smooth Tension:

1. To engage the throttle tension, turn the tension set screw clockwise until the Tension engages.
2. To disengage the throttle Tension turn the screw counter clockwise until the gimbal moves freely.

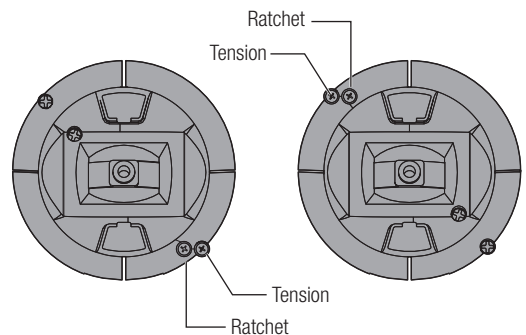

### Adjust Stick Tension

Turn the screws clockwise a small amount using a small Phillips screwdriver to tighten the stick tension and counter clockwise to loosen.

**NOTICE:** Always do a test of stick tension while turning these screws to ensure stick tension is not too loose or too tight. Tightening a screw too much can damage a spring. Loosening a screw too much can let a spring fall off and cause short-circuit in the transmitter.

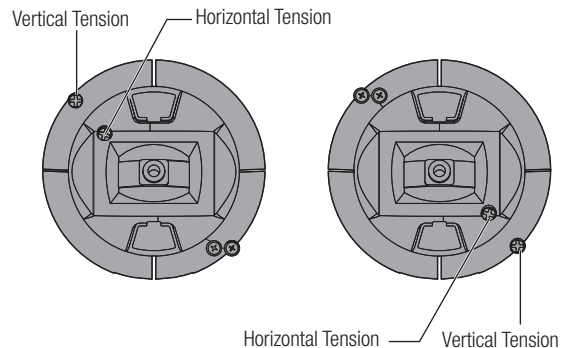

### Control Stick Length Adjustment

1. Using a 2mm Allen wrench, turn the setscrew in the stick counterclockwise to loosen it.
2. Make the stick shorter by turning it clockwise or longer by turning it counterclockwise.
3. After adjustment of stick length, tighten the setscrew.

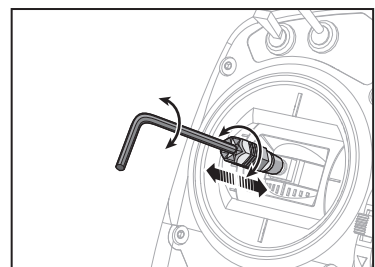

## PHYSICAL TRANSMITTER ADJUSTMENTS

### Mode Change Slider

The DX8e has a unique slider located on the back of the transmitter that allows for simple mode changes. The slider can also be used to change each mode into a “quadcopter mode.” This mode snaps both stick to the center position.

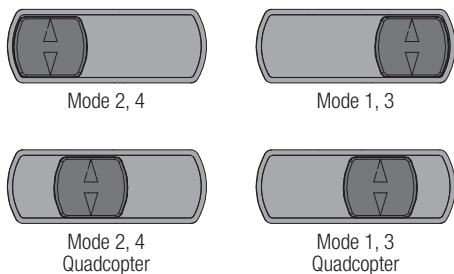
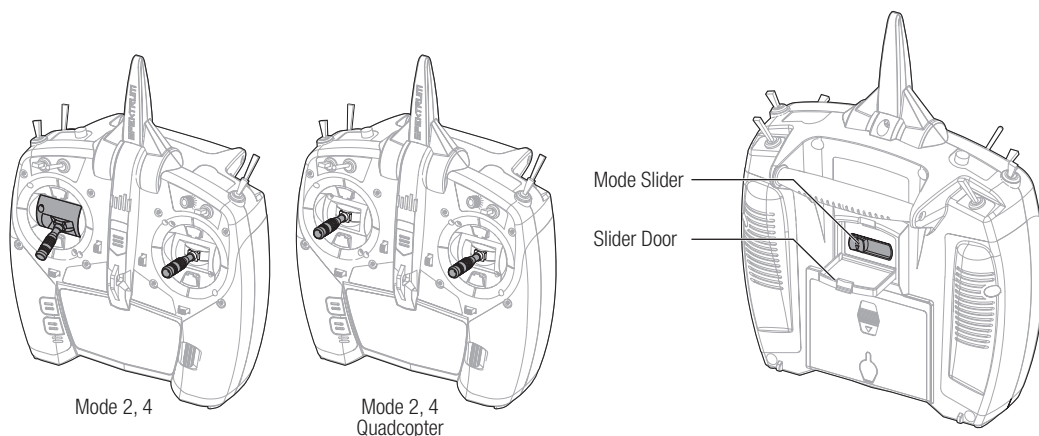

Open the protective slider door and move the slider to the desired position. All changes happen automatically inside the transmitter.

If you are changing from mode 2(4) to mode 1(3) you must first go into the System Settings and change the mode in the programming.

#### Programming Conversion

1. Access the System Settings menu from the Setup List and select the desired Mode.
2. Exit the System Settings menu to save the selection.

#### Calibrating

After changing modes, the transmitter will need to be calibrated. See the calibration section in System Settings.

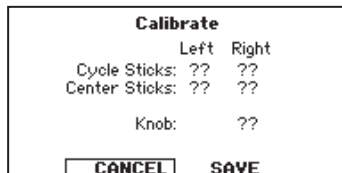
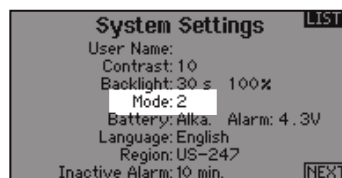

## TROUBLESHOOTING GUIDE

Problem	Possible Cause	Solution
Aircraft will not bind (during binding) to transmitter	Transmitter too near aircraft during binding process	Move powered transmitter a few feet from aircraft, disconnect and reconnect flight battery to aircraft
	Aircraft or transmitter is too close to large metal object	Move the aircraft or transmitter away from the large metal object
	The bind plug is not installed correctly in the bind port	Install bind plug in bind port and bind the aircraft to the transmitter
	Flight battery/Transmitter battery charge is too low	Replace/recharge batteries
	Transmitter is a DX8e EU version and receiver is DSM2	The DX8e EU version is not compatible with DSM2 receivers
Aircraft will not link (after binding) to transmitter	Transmitter too near aircraft during linking process	Move powered transmitter a few feet from aircraft, disconnect and reconnect flight battery to aircraft
	Aircraft or transmitter is too close to large metal object	Move the aircraft or transmitter away from the large metal object
	Bind plug left installed in bind port	Rebind transmitter to the aircraft and remove the bind plug before cycling power
	Aircraft bound to different model memory (ModelMatch™ radios only)	Select correct model memory on transmitter
	Flight battery/Transmitter battery charge is too low	Replace/recharge batteries
	Transmitter may have been bound using different DSM protocol	Bind aircraft to transmitter
	Damaged remote receiver or receiver extension.	Required remote receiver is not connected
The receiver goes into failsafe mode a short distance away from the transmitter	Check the receiver antenna to be sure it is not cut or damaged	Replace or contact Horizon Product Support
	Main and remote receivers too near each other	Install main and remote receivers at least 2 inches (51mm) apart
Receiver quits responding during operation	Low battery voltage	Completely recharge flight battery
	Loose or damaged wires or connectors between battery and receiver	Do a check of the wires and connection between battery and receiver. Repair or replace wires and/or connectors
Receiver loses its bind	Bind button pressed before transmitter powered on	Rebind by performing binding instructions
Receiver slowly blinking at landing (DSM2 Only)	Loss of power to the receiver during flight	Check battery voltage
	System powered on and connected, then receiver powered off without powering off transmitter	Power off transmitter when receiver is powered off
Flight log registers undesirable number of fades, losses or holds or aircraft responds irregularly to controls	Poor signal reception	Reposition remote receivers for improved RF signal path diversity
	Electronic feedback	Check for and stop feedback from servos or motor systems to the ESC or receiver
	Low power	Check aircraft power draw and increase battery power or decrease power demand by installed systems. Ensure all aircraft batteries are fully charged. Ensure the installed BEC for an electric aircraft is adequate for the power demand



# 1-YEAR LIMITED WARRANTY

## What this Warranty Covers

Horizon Hobby, LLC, (Horizon) warrants to the original purchaser that the product purchased (the "Product") will be free from defects in materials and workmanship for a period of 1 year from the date of purchase.

## What is Not Covered

This warranty is not transferable and does not cover (i) cosmetic damage, (ii) damage due to acts of God, accident, misuse, abuse, negligence, commercial use, or due to improper use, installation, operation or maintenance, (iii) modification of or to any part of the Product, (iv) attempted service by anyone other than a Horizon Hobby authorized service center, (v) Product not purchased from an authorized Horizon dealer, (vi) Product not compliant with applicable technical regulations or (vii) use that violates any applicable laws, rules, or regulations.

OTHER THAN THE EXPRESS WARRANTY ABOVE, HORIZON MAKES NO OTHER WARRANTY OR REPRESENTATION, AND HEREBY DISCLAIMS ANY AND ALL IMPLIED WARRANTIES, INCLUDING, WITHOUT LIMITATION, THE IMPLIED WARRANTIES OF NON-INFRINGEMENT, MERCHANTABILITY AND FITNESS FOR A PARTICULAR PURPOSE. THE PURCHASER ACKNOWLEDGES THAT THEY ALONE HAVE DETERMINED THAT THE PRODUCT WILL SUITABLY MEET THE REQUIREMENTS OF THE PURCHASER'S INTENDED USE.

## Purchaser's Remedy

Horizon's sole obligation and purchaser's sole and exclusive remedy shall be that Horizon will, at its option, either (i) service, or (ii) replace, any Product determined by Horizon to be defective. Horizon reserves the right to inspect any and all Product(s) involved in a warranty claim. Service or replacement decisions are at the sole discretion of Horizon. Proof of purchase is required for all warranty claims. SERVICE OR REPLACEMENT AS PROVIDED UNDER THIS WARRANTY IS THE PURCHASER'S SOLE AND EXCLUSIVE REMEDY.

## Limitation of Liability

HORIZON SHALL NOT BE LIABLE FOR SPECIAL, INDIRECT, INCIDENTAL OR CONSEQUENTIAL DAMAGES, LOSS OF PROFITS OR PRODUCTION OR COMMERCIAL LOSS IN ANY WAY, REGARDLESS OF WHETHER SUCH CLAIM IS BASED IN CONTRACT, WARRANTY, TORT, NEGLIGENCE, STRICT LIABILITY OR ANY OTHER THEORY OF LIABILITY, EVEN IF HORIZON HAS BEEN ADVISED OF THE POSSIBILITY OF SUCH DAMAGES. Further, in no event shall the liability of Horizon exceed the individual price of the Product on which liability is asserted. As Horizon has no control over use, setup, final assembly, modification or misuse, no liability shall be assumed nor accepted for any resulting damage or injury. By the act of use, setup or assembly, the user accepts all resulting liability. If you as the purchaser or user are not prepared to accept the liability associated with the use of the Product, purchaser is advised to return the Product immediately in new and unused condition to the place of purchase.

## Law

These terms are governed by Illinois law (without regard to conflict of law principals). This warranty gives you specific legal rights, and you may also have other rights which vary from state to state. Horizon reserves the right to change or modify this warranty at any time without notice.

## WARRANTY SERVICES

### Questions, Assistance, and Services

Your local hobby store and/or place of purchase cannot provide warranty support or service. Once assembly, setup or use of the Product has been started, you must contact your local distributor or Horizon directly. This will enable Horizon to better answer your

questions and service you in the event that you may need any assistance. For questions or assistance, please visit our website at [www.horizonhobby.com](http://www.horizonhobby.com), submit a Product Support Inquiry, or call the toll free telephone number referenced in the Warranty and Service Contact Information section to speak with a Product Support representative.

## Inspection or Services

If this Product needs to be inspected or serviced and is compliant in the country you live and use the Product in, please use the Horizon Online Service Request submission process found on our website or call Horizon to obtain a Return Merchandise Authorization (RMA) number. Pack the Product securely using a shipping carton. Please note that original boxes may be included, but are not designed to withstand the rigors of shipping without additional protection. Ship via a carrier that provides tracking and insurance for lost or damaged parcels, as Horizon is not responsible for merchandise until it arrives and is accepted at our facility. An Online Service Request is available at [http://www.horizonhobby.com/content/service-center\\_render-service-center](http://www.horizonhobby.com/content/service-center_render-service-center). If you do not have internet access, please contact Horizon Product Support to obtain a RMA number along with instructions for submitting your product for service. When calling Horizon, you will be asked to provide your complete name, street address, email address and phone number where you can be reached during business hours. When sending product into Horizon, please include your RMA number, a list of the included items, and a brief summary of the problem. A copy of your original sales receipt must be included for warranty consideration. Be sure your name, address, and RMA number are clearly written on the outside of the shipping carton.

**NOTICE: Do not ship LiPo batteries to Horizon. If you have any issue with a LiPo battery, please contact the appropriate Horizon Product Support office.**

## Warranty Requirements

For Warranty consideration, you must include your original sales receipt verifying the proof-of-purchase date. Provided warranty conditions have been met, your Product will be serviced or replaced free of charge. Service or replacement decisions are at the sole discretion of Horizon.

## Non-Warranty Service

**Should your service not be covered by warranty, service will be completed and payment will be required without notification or estimate of the expense unless the expense exceeds 50% of the retail purchase cost.** By submitting the item for service you are agreeing to payment of the service without notification. Service estimates are available upon request. You must include this request with your item submitted for service. Non-warranty service estimates will be billed a minimum of ½ hour of labor. In addition you will be billed for return freight. Horizon accepts money orders and cashier's checks, as well as Visa, MasterCard, American Express, and Discover cards. By submitting any item to Horizon for service, you are agreeing to Horizon's Terms and Conditions found on our website [http://www.horizonhobby.com/content/service-center\\_render-service-center](http://www.horizonhobby.com/content/service-center_render-service-center).

**ATTENTION: Horizon service is limited to Product compliant in the country of use and ownership. If received, a non-compliant Product will not be serviced. Further, the sender will be responsible for arranging return shipment of the un-serviced Product, through a carrier of the sender's choice and at the sender's expense. Horizon will hold non-compliant Product for a period of 60 days from notification, after which it will be discarded.**

## WARRANTY AND SERVICE CONTACT INFORMATION

Country of Purchase	Horizon Hobby	Contact Information	Address
United States of America	Horizon Service Center (Repairs and Repair Requests)	servicecenter.horizonhobby.com/ RequestForm/	4105 Fieldstone Rd Champaign, Illinois, 61822 USA
	Horizon Product Support (Product Technical Assistance)	productsupport@horizonhobby.com 877-504-0233	
	Sales	websales@horizonhobby.com 800-338-4639	
Germany	Horizon Technischer Service	service@horizonhobby.de	Hanskampring 9 D 22885 Barsbüttel, Germany
	Sales: Horizon Hobby GmbH	+49 (0) 4121 2655 100	

## FCC INFORMATION

### FCC ID: BRWDAMTX12

### FCC ID: BRWDASRX20

This equipment has been tested and found to comply with the limits for Part 15 of the FCC rules. These limits are designed to provide reasonable protection against harmful interference in a residential installation. This equipment generates uses and can radiate radio frequency energy and, if not installed and used in accordance with the instructions, may cause harmful interference to radio communications.

However, there is no guarantee that interference will not occur in a particular installation. If this equipment does cause harmful interference to radio or television reception, which can be determined by turning the equipment off and on, the user is encouraged to try to correct the interference by one or more of the following measures:

- Reorient or relocate the receiving antenna.
- Increase the separation between the equipment and receiver.
- Connect the equipment to an outlet on a circuit different from that to which the receiver is connected.

This device complies with part 15 of the FCC rules. Operation is subject to the following two conditions: (1) This device may not cause harmful interference, and (2) this device must accept any interference received, including interference that may cause undesired operation.

**NOTICE:** Modifications to this product will void the user's authority to operate this equipment.

### Antenna Separation Distance

When operating your Spektrum transmitter, please be sure to maintain a separation distance of at least 5 cm between your body (excluding fingers, hands, wrists, ankles and feet) and the antenna to meet RF exposure safety requirements as determined by FCC regulations.

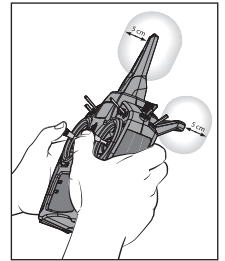

The following illustration shows the approximate 5 cm RF exposure area and typical hand placement when operating your Spektrum transmitter.

## IC INFORMATION

### IC: 6157A-AMTX12

### IC: 6157A-AMRX10

This device complies with Industry Canada licence-exempt RSS standard(s). Operation is subject to the following two conditions:

(1) this device may not cause interference, and (2) this device must accept any interference, including interference that may cause undesired operation of the device.

## FAA INFORMATION

Prior to flying, contact your local or regional modeling organizations for guidance and familiarize yourself with the current local rules and FAA regulations governing model aviation in your location.

More information about model aviation can be found at [www.modelaircraft.org](http://www.modelaircraft.org).

The Federal Aviation Administration can be found online at [www.faa.gov](http://www.faa.gov).

## AMA NATIONAL MODEL AIRCRAFT SAFETY CODE

<http://www.modelaircraft.org/files/105.PDF>

## COMPLIANCE INFORMATION FOR THE EUROPEAN UNION



Horizon Hobby, LLC hereby declares that this product is in compliance with the essential requirements and other relevant provisions of the RED Directive.

A copy of the EU Declaration of Conformity is available online at: <http://www.horizonhobby.com/content/support-render-compliance>.



### Instructions for disposal of WEEE by users in the European Union

This product must not be disposed of with other waste. Instead, it is the user's responsibility to dispose of their waste equipment by handing it over to a designated collections point for the recycling of waste electrical and electronic equipment. The separate collection and recycling of your waste equipment at the time of disposal will help to conserve natural resources and ensure that it is recycled in a manner that protects human health and the environment. For more information about where you can drop off your waste equipment for recycling, please contact your local city office, your household waste disposal service or where you purchased the product.



E328

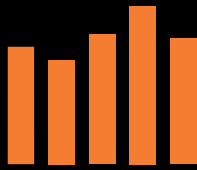

**SPEKTRUM®**

© 2018 Horizon Hobby, LLC

DSM, DSM2, DSMX, the DSMX logo, the BNF logo, AirWare, ModelMatch, X-Plus, AS3X, SmartSafe, Hangar 9 and the Horizon Hobby logo are trademarks or registered trademarks of Horizon Hobby, LLC.

The Spektrum trademark is used with permission of Bachmann Industries, Inc.

The SD Logo is a trademark of SD-3C, LLC

US 7,391,320. Other patents pending.

[www.spektrumrc.com](http://www.spektrumrc.com)

Created 02/18 ▪ 57542 ▪ SPMR8100